



ASHRAE STANDARD

Standard Method of Test for the Evaluation of Building Energy Analysis Computer Programs

Approved by the ASHRAE Standards Committee on January 23, 2010; by the ASHRAE Board of Directors on January 27, 2010; and by the American National Standards Institute on January 28, 2010.

This standard is under continuous maintenance by a Standing Standard Project Committee (SSPC) for which the Standards Committee has established a documented program for regular publication of addenda or revisions, including procedures for timely, documented, consensus action on requests for change to any part of the standard. The change submittal form, instructions, and deadlines may be obtained in electronic form from the ASHRAE Web site, <http://www.ashrae.org>, or in paper form from the Manager of Standards. The latest edition of an ASHRAE Standard may be purchased from ASHRAE Customer Service, 1791 Tullie Circle, NE, Atlanta, GA 30329-2305. E-mail: orders@ashrae.org. Fax: 404-321-5478. Telephone: 404-636-8400 (worldwide), or toll free 1-800-527-4723 (for orders in US and Canada). For reprint permission, go to www.ashrae.org/permissions.

© Copyright 2010 American Society of Heating, Refrigerating and Air-Conditioning Engineers, Inc.

ISSN 1041-2336



**American Society of Heating, Refrigerating
and Air-Conditioning Engineers, Inc.**
1791 Tullie Circle NE, Atlanta, GA 30329
www.ashrae.org

ASHRAE Standing Standard Project Committee 140
Cognizant TC: TC 4.7, Energy Calculations
SPLS Liaison: Nadar R. Jayaraman

Ronald D. Judkoff, *Chair**
Joel Neymark, *Vice-Chair*
Ian Beausoleil-Morrison
Drury B. Crawley*
Philip W. Fairey, III*
Kamel Haddad*

Sean P. Kolling
David E. Knebel*
Timothy P. McDowell*
James F. Pegues*
Simon J. Rees*
Michael J. Witte*

*Denotes members of voting status when the document was approved for publication

ASHRAE STANDARDS COMMITTEE 2009–2010

Steven T. Bushby, *Chair*
H. Michael Newman, *Vice-Chair*
Robert G. Baker
Michael F. Beda
Hoy R. Bohanon, Jr.
Kenneth W. Cooper
K. William Dean
Martin Dieryckx
Allan B. Fraser
Katherine G. Hammack
Nadar R. Jayaraman
Byron W. Jones
Jay A. Kohler
Carol E. Marriott

Merle F. McBride
Frank Myers
Janice C. Peterson
Douglas T. Reindl
Lawrence J. Schoen
Boggarm S. Setty
Bodh R. Subherwal
James R. Tauby
James K. Vallort
William F. Walter
Michael W. Woodford
Craig P. Wray
Wayne R. Reedy, *BOD ExO*
Thomas E. Watson, *CO*

Stephanie Reiniche, *Manager of Standards*

SPECIAL NOTE

This American National Standard (ANS) is a national voluntary consensus standard developed under the auspices of the American Society of Heating, Refrigerating and Air-Conditioning Engineers (ASHRAE). *Consensus* is defined by the American National Standards Institute (ANSI), of which ASHRAE is a member and which has approved this standard as an ANS, as “substantial agreement reached by directly and materially affected interest categories. This signifies the concurrence of more than a simple majority, but not necessarily unanimity. Consensus requires that all views and objections be considered, and that an effort be made toward their resolution.” Compliance with this standard is voluntary until and unless a legal jurisdiction makes compliance mandatory through legislation.

ASHRAE obtains consensus through participation of its national and international members, associated societies, and public review.

ASHRAE Standards are prepared by a Project Committee appointed specifically for the purpose of writing the Standard. The Project Committee Chair and Vice-Chair must be members of ASHRAE; while other committee members may or may not be ASHRAE members, all must be technically qualified in the subject area of the Standard. Every effort is made to balance the concerned interests on all Project Committees.

The Manager of Standards of ASHRAE should be contacted for:

- a. interpretation of the contents of this Standard,
- b. participation in the next review of the Standard,
- c. offering constructive criticism for improving the Standard, or
- d. permission to reprint portions of the Standard.

DISCLAIMER

ASHRAE uses its best efforts to promulgate Standards and Guidelines for the benefit of the public in light of available information and accepted industry practices. However, ASHRAE does not guarantee, certify, or assure the safety or performance of any products, components, or systems tested, installed, or operated in accordance with ASHRAE's Standards or Guidelines or that any tests conducted under its Standards or Guidelines will be nonhazardous or free from risk.

ASHRAE INDUSTRIAL ADVERTISING POLICY ON STANDARDS

ASHRAE Standards and Guidelines are established to assist industry and the public by offering a uniform method of testing for rating purposes, by suggesting safe practices in designing and installing equipment, by providing proper definitions of this equipment, and by providing other information that may serve to guide the industry. The creation of ASHRAE Standards and Guidelines is determined by the need for them, and conformance to them is completely voluntary.

In referring to this Standard or Guideline and in marking of equipment and in advertising, no claim shall be made, either stated or implied, that the product has been approved by ASHRAE.

(This foreword is not part of this standard. It is merely informative and does not contain requirements necessary for conformance to the standard. It has not been processed according to the ANSI requirements for a standard and may contain material that has not been subject to public review or a consensus process. Unresolved objectors on informative material are not offered the right to appeal at ASHRAE or ANSI.)

FOREWORD

The purpose of this addendum is to add a new set of test cases within new Section 7 of Standard 140. These test cases were adapted from HERS BESTEST, developed by the National Renewable Energy Laboratory.^{B-1} This set of test cases formally codifies the Tier 1 and Tier 2 Tests for certification of residential energy performance analysis tools, as described in the 2006 Mortgage Industry National Home Energy Rating Systems Standards.^{B-2}

Section 7 is added so that test cases can be divided into separate test classes to satisfy different levels of software modeling detail. Such classification allows more convenient citation of specific sections of Standard 140 by other codes and standards, and certifying and accrediting agencies, as appropriate. The current Class I test cases (Section 5) are detailed diagnostic tests intended for simulation software capable of hourly or sub-hourly simulation time steps. The new Class II (Section 7) test cases of this addendum may be used for all types of building load calculation methods, regardless of time-step granularity. The Class I (Section 5) test cases are designed for more detailed diagnosis of simulation models than the Class II (Section 7) test cases.

Test procedures added to Section 7 are divided into Tier 1 and Tier 2 tests. The Tier 1 base building plan is a single-story house with 1539 ft² of floor area, with one conditioned zone (the main floor), an unconditioned attic, a raised floor exposed to air, and typical glazing and insulation. Additional Tier-1 cases test the ability of software to model building envelope loads in the base-case configuration with the following variations: infiltration; wall and ceiling R-Value; glazing physical properties, area and orientation; shading by a south overhang; internal loads; exterior surface color; energy inefficient building; raised floor exposed to air; un-insulated and insulated slab-on-grade; un-insulated and insulated basement. The Tier-2 tests consist of the following additional elements related to passive solar design: variation in mass, glazing orientation, east and west shading, glazing area, and south overhang. These test cases were developed in a more realistic residential context, and have a more complex base building construction, than the Section 5 test cases (which have more idealized and simplified construction for enhancement of diagnostic capability). To help avoid user input errors for the Section 7 test cases, the input for the test cases is simple, while remaining as close as possible to "typical" residential constructions and thermal and physical properties. Typical building descriptions and physical properties published by sources such as the National Association of Home Builders, the U.S. Department of Energy, American Society of Heating Refrigerating and Air Conditioning Engineers, and

the National Fenestration Rating Council are used for the Section 7 test cases.

New informative (non-mandatory) Annex B22, included with this addendum, provides an example procedure for establishing acceptance range criteria to assess annual or seasonal heating and cooling load results from software undergoing tests contained in Section 7 of Standard 140. Inclusion of this example is intended to be illustrative only, and does not imply in any way that results from software tests are required by Standard 140 to be within any specific limits. However, certifying or accrediting agencies using Section 7 of Standard 140 may wish to adopt procedures for developing acceptance-range criteria for tested software. Informative Annex B22 presents an example range setting methodology that may be useful for these purposes.

Summary of changes in this addendum:

- Add new Section 7 "Class II Test Procedures" (This is the major substantive portion of the addendum)
- Add new Section 8 "Class II Output Requirements"
- Update Section 3 "Definitions, Abbreviations, and Acronyms" for language of Section 7
- Update Section 4 "Methods of Testing" (overall Standard 140 roadmap), to summarize new classification of tests (i.e., Class I and Class II), and summarize new Section 7 test cases
- Changes titles of Sections 5 and 6 to "Class I Test Procedures" and "Class I Output Requirements", and add introductory text to Section 5 to indicate new classification of test procedures
- Update normative Annex A1 "Weather Data", to include weather data used for Section 7
- Include new informative annexes to provide information relevant for the Section 7 test procedures:
 - B18 Alternative Section 7 Ground Coupling Analysis Case Descriptions for Developing Additional Example Results for Cases L302B, L304B, L322B, and L324B
 - B19 Distribution of Solar Radiation in the Section 7 Passive Solar Base Case (P100A)
 - B20 Example Results for Section 7 Test Procedures
 - B21 Production of Example Results for Section 7 Test Procedures
 - B22 Example Procedures for Developing Acceptance-Range Criteria for Section 7 Test Cases
- Update the following informative annexes to include new information relevant for Section 7 test procedures:
 - B1 Tabular Summary of Test Cases
 - B2 About TMY Weather Data
 - B3 Infiltration and Fan Adjustments for Altitude
 - B4 Exterior Combined Radiative and Convective Surface Coefficients
 - B5 Infrared Portion of Film Coefficients
 - B7 Detailed Calculation of Solar Fractions
 - B10 Instructions for Working with Results Spreadsheets Provided with the Standard
 - B23 (renumbered from B18) Validation Methodologies and Other Research Relevant to Standard 140
 - B24 (renumbered from B19) Informative References

- *Update titles of the following informative annexes to indicate specificity for Section 5 test procedures:*
 - *B8 Example Results for Building Thermal Envelope and Fabric Load Tests of Section 5.2*
 - *B11 Production of Example Results for Building Thermal Envelope and Fabric Load Tests of Section 5.2*
 - *B16 Analytical and Quasi-Analytical Solution Results and Example Simulation Results for HVAC Equipment Performance Tests of Sections 5.3 and 5.4*
 - *B17 Production of Quasi-Analytical Solution Results and Example Simulation Results for HVAC Equipment Performance Tests of Sections 5.3 and 5.4*

[Informative Note: Additions are shown in this addendum by underlining and deletions are shown by ~~strikethrough~~ except when an informative note makes it clear that the entire material that follows is to be added or deleted as a whole. The changes shown in this addendum are relative to the 2007 edition of the standard—as modified by published Addendum a.]

Addendum b to 140-2007

[Informative note: Revisions to Contents indicated below; deletions indicated by strikethrough text; additions indicated by underline text.]

CONTENTS

Foreword

- 1 Purpose
- 2 Scope
- 3 Definitions, Abbreviations, and Acronyms
- 4 Methods of Testing
- 5 Class I Test Procedures
- 6 Class I Output Requirements
- 7 Class II Test Procedures
- 8 Class II Output Requirements

Normative Annexes

- Annex A1 Weather Data
- Annex A2 Standard Output Reports

Informative Annexes

- Annex B1 Tabular Summary of Test Cases
- Annex B2 About Typical Meteorological Year (TMY) Weather Data
- Annex B3 Infiltration and Fan Adjustments for Altitude
- Annex B4 Exterior Combined Radiative and Convective Surface Coefficients
- Annex B5 Infrared Portion of Film Coefficients
- Annex B6 Incident Angle-Dependent Window Optical Property Calculations
- Annex B7 Detailed Calculation of Solar Fractions
- Annex B8 Example Results for Building Thermal Envelope and Fabric Load Tests of Section 5.2

- Annex B9 Diagnosing the Results Using the Flow Diagrams
- Annex B10 Instructions for Working with Results Spreadsheets Provided with the Standard
- Annex B11 Production of Example Results for Building Thermal Envelope and Fabric Load Tests of Section 5.2
- Annex B12 Temperature Bin Conversion Program
- Annex B13 COP Degradation Factor (CDF) as a Function of Part-Load Ratio (PLR)
- Annex B14 Cooling Coil Bypass Factor
- Annex B15 Indoor Fan Data Equivalence
- Annex B16 Analytical and Quasi-Analytical Solution Results and Example Simulation Results for HVAC Equipment Performance Tests of Sections 5.3 and 5.4
- Annex B17 Production of Quasi-Analytical Solution Results and Example Simulation Results for HVAC Equipment Performance Tests of Sections 5.3 and 5.4
- Annex B18 Alternative Section 7 Ground Coupling Analysis Case Descriptions for Developing Additional Example Results for Cases L302B, L304B, L322B and L324B
- Annex B19 Distribution of Solar Radiation in the Section 7 Passive Solar Base Case (P100A)
- Annex B20 Example Results for Section 7 Test Procedures
- Annex B21 Production of Example Results for Section 7 Test Procedures
- Annex B22 Example Procedures for Developing Acceptance-Range Criteria for Section 7 Test Cases
- Annex B~~23~~¹⁸ Validation Methodologies and Other Research Relevant to Standard 140
- Annex B~~24~~¹⁹ Informative References
- Annex C Addenda Description Information

3.1 Terms Defined for This Standard

[Informative note: Add the following definitions to Section 3.1; cross-referenced definitions included for review convenience; all other definitions are unchanged.]

cavity albedo: see *solar lost through window*.

combined radiative and convective surface coefficient: constant of proportionality relating the rate of combined convective and radiative heat transfer at a surface to the temperature difference across the air film on that surface.

exterior film: as used in Section 7, see *combined radiative and convective surface coefficient*.

film coefficient: see *combined radiative and convective surface coefficient*.

hemispherical infrared emittance: average directional infrared emittance over a hemispherical envelope over the surface. *Also see infrared emittance*.

infrared emittance: the ratio of the infrared spectrum radiant flux emitted by a body to that emitted by a blackbody at the same temperature and under the same conditions.

interior film: as used in Section 7, see *combined radiative and convective surface coefficient*.

interior solar distribution: the fraction of transmitted solar radiation incident on specific surfaces in a room. Also see *solar distribution fraction*.

raised floor exposed to air: floor system where the air temperature below the floor is assumed to equal the outdoor air temperature, the underside of the conditioned-zone floor has an exterior film coefficient consistent with a "rough" surface texture and zero wind speed, and the conditioned-zone floor exterior surface (surface facing the raised floor) receives no solar radiation, also see Section 7.2.1.5.

solar distribution fraction: the fraction of total solar radiation transmitted through the window(s) that is absorbed by a given surface or retransmitted (lost) back out the window(s).

solar lost: see *solar lost through window*.

solar lost through window: the fraction of total solar radiation transmitted through the window(s) that is reflected by opaque surfaces and retransmitted back out the window(s).

3.2 Abbreviations and Acronyms Used in This Standard

[Informative note: Add the following abbreviations to Section 3.2 relevant to new language of this addendum; for Cp, k, R, and U dual units are now provided; all other abbreviations are unchanged.]

A	area
Abs In	absorptance of inner pane
Abs Out	absorptance of outer pane
Base	base case
COG	center of glass
Cp	specific heat, J/(kg·K) [Btu/(lb·F)]
D	door 3' x 6'8"
Dir. Nor.	direct normal
DOE	United States Department of Energy
EOG	edge of glass
Heatcap	heat capacity
Hemis	hemispherical
HERS	Home Energy Rating System
IEA	International Energy Agency
k	thermal conductivity, W/(m·K) [Btu/(h·ft ² ·°F)]
LCR	load to collector area ratio
Low-E	low emissivity
NAHB	National Association of Home Builders
NFRC	National Fenestration Rating Council
NREL	National Renewable Energy Laboratory
O.C.	on centers
PROP	property
R	unit thermal resistance, m ² ·K/W [h·ft ² ·°F/Btu]
SC	shading coefficient
S.G.L.A	net south glass area (excluding window frames)
U	unit thermal conductance or overall heat transfer coefficient, W/(m ² ·K) [Btu/(h·ft ² ·°F)]

UA _{inf}	equivalent thermal conductance due to infiltration
UV	ultraviolet
Val	value
W	window, 3' x 5'
W _p	window 2'6" x 6'6"
α _{ext}	exterior solar absorptance

4. METHODS OF TESTING

[Informative Note: Make revisions in Section 4 as shown; all of Section 4 as revised by 140-2007 Addendum a (Data Format) is shown here. Changes include reference to the new test cases of Section 7.2 and other related annexes, and related editorial revisions.]

4.1 Applicability of Test Method The method of test is provided for analyzing and diagnosing building energy simulation software using software-to-software, software-to-analytical-solution and software-to-quasi-analytical-solution comparisons. The methodology allows different building energy simulation programs, representing different degrees of modeling complexity, to be tested by

- comparing the predictions from other building energy simulation programs to the example simulation results provided in informative Annex B8, to the example analytical and quasi-analytical solutions and simulation results in the informative Annex B16, to the example simulation results provided in Informative Annex B20, and/or to other results (simulations or analytical and quasi-analytical solutions) that were generated using this standard method of test;
- checking a program against a previous version of itself after internal code modifications to ensure that only the intended changes actually resulted;
- checking a program against itself after a single algorithmic change to understand the sensitivity between algorithms;
- diagnosing the algorithmic sources of prediction differences; diagnostic logic flow diagrams are included in the informational Annex B9.

4.2 Organization of Test Cases The specifications for determining test case configurations and input values are provided case-by-case in Section 5 on a case-by-case basis in Section 5 and Section 7. The test cases are divided into two separate test classes to satisfy various levels of software modeling detail. Such classification allows more convenient citation of specific sections of Standard 140 by other codes and standards, and certifying and accrediting agencies, as appropriate. The Class I tests cases (Section 5) are detailed diagnostic tests intended for simulation software capable of hourly or sub-hourly simulation time steps. The Class II test cases (Section 7) may be used for all types of building load calculation methods, regardless of time-step granularity. The Class I (Section 5) test cases are designed for more detailed diagnosis of simulation models than the Class II (Section 7) test cases.

Weather information required for use with the test cases is provided as described in Annex A1. Annex B1 provides an overview for all the test cases and contains information on those building parameters that change from case to case; Annex B1 is recommended for preliminary review of the tests, but do not use it for defining the cases. Additional information regarding the meaning of the cases is shown in the informational Annex B9 on diagnostic logic. In some instances (e.g., Case 620, Section 5.2.2.1.2), a case developed from modifications to a given base case (e.g., Case 600, Section 5.2.1) will also serve as the base case for other cases. The cases are grouped as:

(a) Class I test procedures

- a. 1) Building Thermal Envelope and Fabric Load Base Case (see Section 4.2.1.1)
- b. 2) Building Thermal Envelope and Fabric Load Basic Tests (see Section 4.2.1.2)
 - Low mass (see Section 4.2.1.2.1)
 - High mass (see Section 4.2.1.2.2)
 - Free float (see Section 4.2.1.2.3)
- c. 3) Building Thermal Envelope and Fabric Load In-Depth Tests (see Section 4.2.1.3)
- d. 4) Space-Cooling Equipment Performance Analytical Verification Base Case (see Section 4.2.1.4)
- e. 5) Space-Cooling Equipment Performance Parameter Variation Analytical Verification Tests (see Section 4.2.1.5)
- f. 6) Space-Cooling Equipment Performance Comparative Test Base Case (see Section 4.2.1.6)
- g. 7) Space-Cooling Equipment Performance Comparative Tests (see Section 4.2.1.7)
- h. 8) Space-Heating Equipment Performance Analytical Verification Base Case (see Section 4.2.1.8)
- i. 9) Space-Heating Equipment Performance Analytical Verification Tests (see Section 4.2.1.9)
- j. 10) Space-Heating Equipment Performance Comparative Tests (see Section 4.2.1.10)

(b) Class II test procedures

- 1) Building Thermal Envelope and Fabric Load Base Case (see Section 4.2.2.1)
- 2) Building Thermal Envelope and Fabric Load Tier-1 Tests (see Section 4.2.2.2)
- 3) Building Thermal Envelope and Fabric Load Tier-2 Tests (see Section 4.2.2.3)

4.2.1 Class I Test Procedures.

4.2.1.1 Building Thermal Envelope and Fabric Load Base Case. The base building plan is a low mass, rectangular single zone with no interior partitions. It is presented in detail in Section 5.2.1.

4.2.1.2 Building Thermal Envelope and Fabric Load Basic Tests. The basic tests analyze the ability of software to model building envelope loads in a low mass configuration with the following variations: window orientation, shading devices, setback thermostat, and night ventilation.

4.2.1.2.1 The low mass basic tests (Cases 600 through 650) utilize lightweight walls, floor, and roof. They are presented in detail in Section 5.2.2.1.

4.2.1.2.2 The high mass basic tests (Cases 900 through 960) utilize masonry walls and concrete slab floor and include an additional configuration with a sunspace. They are presented in detail in Section 5.2.2.2.

4.2.1.2.3 Free-float basic tests (Cases 600FF, 650FF, 900FF, and 950FF) have no heating or cooling system. They analyze the ability of software to model zone temperature in both low mass and high mass configurations with and without night ventilation. The tests are presented in detail in Section 5.2.2.3.

4.2.1.3 Building Thermal Envelope and Fabric Load In-Depth Tests. The in-depth cases are presented in detail in Section 5.2.3.

4.2.1.3.1 In-depth Cases 195 through 320 analyze the ability of software to model building envelope loads for a nondeadband ON/OFF thermostat control configuration with the following variations among the cases: no windows, opaque windows, exterior infrared emittance, interior infrared emittance, infiltration, internal gains, exterior shortwave absorptance, south solar gains, interior shortwave absorptance, window orientation, shading devices, and thermostat set-points. These are a detailed set of tests designed to isolate the effects of specific algorithms. However, some of the cases may be incompatible with some building energy simulation programs.

4.2.1.3.2 In-depth Cases 395 through 440, 800, and 810 analyze the ability of software to model building envelope loads in a deadband thermostat control configuration with the following variations: no windows, opaque windows, infiltration, internal gains, exterior shortwave absorptance, south solar gains, interior shortwave absorptance, and thermal mass. This series of in-depth tests is designed to be compatible with more building energy simulation programs. However, the diagnosis of software using this test series is not as precise as for Cases 195 through 320.

4.2.1.4 Space-Cooling Equipment Performance Analytical Verification Base Case. The configuration of the base-case (Case CE100) building is a near-adiabatic rectangular single zone with only user-specified internal gains to drive steady-state cooling load. Mechanical equipment specifications represent a simple unitary vapor-compression cooling system or, more precisely, a split-system, air-cooled condensing unit with an indoor evaporator coil. Performance of this equipment is typically modeled using manufacturer design data presented in the form of empirically derived performance maps. This case is presented in detail in Section 5.3.1.

4.2.1.5 Space-Cooling Equipment Performance Parameter Variation Analytical Verification Tests. In these steady-state cases (cases CE110 through CE200), the following parameters are varied: sensible internal gains, latent internal gains, zone thermostat setpoint (entering dry-bulb temperature [EDB]), and ODB. Parametric variations isolate the effects of the parameters singly and in various combinations and isolate the influence of: part-loading of equipment, varying sensible heat ratio, “dry” coil (no latent load) versus “wet” coil (with dehumidification) operation, and operation at typical Air-Conditioning and Refrigeration Institute (ARI) rating conditions. In this way the models are

tested in various domains of the performance map. These cases are presented in detail in Section 5.3.2.

4.2.1.6 Space-Cooling Equipment Performance Comparative Test Base Case. The configuration of this base case (Case CE300) is a near-adiabatic rectangular single zone with user-specified internal gains and outside air to drive dynamic (hourly-varying) loads. The cases apply realistic, hourly-varying annual weather data for a hot and humid climate. The mechanical system is a vapor-compression cooling system similar to that described in Section 4.2.1.4, except that it is a larger system and includes an expanded performance data set covering a wider range of operating conditions (i.e., wider range of ODB, EDB, and EWB, the entering wet-bulb temperature). Also, an air mixing system is present so that outside-air mixing and economizer control models can be tested. This case is presented in detail in Section 5.3.3.

4.2.1.7 Space-Cooling Equipment Performance Comparative Tests. In these cases (cases CE310 through CE545), which apply the same weather data as Case CE300, the following parameters are varied: sensible internal gains, latent internal gains, infiltration rate, outside air fraction, thermostat set points, and economizer control settings. Results analysis also isolates the influence of part loading of equipment, ODB sensitivity, and “dry” coil (no latent load) versus “wet” coil (with dehumidification) operation. These cases help to scale the significance of simulation results disagreements for a realistic context, which is less obvious in the steady-state cases described above. These cases are presented in detail in Section 5.3.4.

4.2.1.8 Space-Heating Equipment Performance Analytical Verification Base Case. The configuration of the base-case (Case HE100) building is a rectangular single zone that is near-adiabatic on five faces with one heat exchange surface (the roof). Mechanical equipment specifications represent a simple unitary fuel fired furnace with a circulating fan and a draft fan. Performance of this equipment is typically modeled using manufacturer design data presented in the form of empirically derived performance maps. This case is presented in detail in Section 5.4.1.

4.2.1.9 Space-Heating Equipment Performance Analytical Verification Tests. In these cases (cases HE110 through HE170), the following parameters are varied: efficiency, weather (resulting in different load conditions from full load to part load to no load to time varying load), circulating fan operation, and draft fan operation. In this way the basic functionalities of the models are tested in various domains of the performance map. These cases are presented in detail in Section 5.4.2.

4.2.1.10 Space-Heating Equipment Performance Comparative Tests. In these cases (cases HE210 through HE230), the following parameters are varied: weather (realistic temperature conditions are used), thermostat control strategy, and furnace size (undersized furnace). In this way the models are tested with more realistic conditions in various domains of the performance map. These cases also test the interactions between furnace, control, and zone models. They are presented in detail in Section 5.4.3.

4.2.2 Class II Test Procedures.

4.2.2.1 Building Thermal Envelope and Fabric Load

Base Case. The base building plan is a 1539 ft² single-story house with one conditioned zone (the main floor), an unconditioned attic and a raised floor exposed to air. It is presented in detail in Section 7.2.1.

4.2.2.2 Building Thermal Envelope and Fabric Load

Tier-1 Tests. The Tier-1 cases test the ability of software to model building envelope loads in the base-case configuration with the following variations: infiltration; wall and ceiling R-Value; glazing physical properties, area and orientation; shading by a south overhang; internal loads; exterior surface color; energy inefficient building; raised floor exposed to air; un-insulated and insulated slab-on-grade; un-insulated and insulated basement. The Tier-1 Tests are presented in detail in Section 7.2.2.

4.2.2.3 Building Thermal Envelope and Fabric Load

Tier-2 Tests. The Tier-2 tests consist of the following additional elements related to passive solar design: variation in mass, glazing orientation, east and west shading, glazing area, and south overhang. The Tier-2 tests are presented in detail in Section 7.2.3.

4.3 Reporting Results

4.3.1 Standard Output Reports. The standard output reports included on the accompanying electronic media shall be used. Instructions regarding these reports are included in Annex A2. Information required for this report includes

- a. software name and version number,
- b. modeling documentation using “S140outNotes.TXT” on the accompanying electronic media for:
 - Software identifying information and operating requirements
 - Modeling methods used when alternative methods are available in the software
 - Equivalent modeling methods used when the software does not allow direct input of specified values
 - Omitted test cases and results
 - Changes to source code for the purpose of running the tests, where such changes are not available in publicly released versions of the software
 - Anomalous results
- c. results for simulated cases using the following files on the accompanying electronic media:
 - Sec5-2out.XLS for the building thermal envelope and fabric load tests of Section 5.2
 - Sec5-3Aout.XLS for the space cooling equipment performance analytical verification tests of Sections 5.3.1 and 5.3.2
 - Sec5-3Bout.XLS for the space cooling equipment performance comparative tests of Sections 5.3.3 and 5.3.4
 - Sec5-4out.XLS for the space heating equipment performance tests of Section 5.4
 - RESULTS7-2.XLS, sheet tab ‘Sec7-2out’ for the building thermal envelope and fabric load tests of Section 7.2.

Output quantities to be included in the results report are called out specifically for each case, as they appear in the appropriate subsections of Sections 5.2, 5.3, ~~and 5.4, and 7.2.~~

If a program being tested omits a test case, the modeler shall provide an explanation using the modeler report template provided in Annex A2.

4.3.2 Simulation Input Files. All supporting data required for generating results with the tested software shall be saved, including:

- Input files
- Processed weather data
- Intermediate files containing calculations used for developing inputs
- A “Readme-software-name-yyymmdd.pdf” file that briefly describes the contents of the above files according to their file type (i.e., their “.xyz” file extension).

4.4 Comparing Output to Other Results For Class I test procedures, Annex B8 gives example simulation results for the building thermal envelope and fabric load tests; and Annex B16 gives quasi-analytical solution results and example simulation results for the HVAC equipment performance tests. For Class II test procedures, Annex B20 gives example simulation results. The user may choose to compare output with the example results provided in Annex B8, ~~and Annex B16 and Annex B20~~ or with other results that were generated using this standard method of test (including self-generated quasi-analytical solutions related to the HVAC equipment performance tests). For Class I test procedures, information about how the example results were produced is included in informational Annex B11 and Annex B17 for building thermal envelope and fabric load tests, and in informative Annex B17 for HVAC equipment performance tests, respectively. For Class II test procedures, information about how the example results were produced is included in informational Annex B21. For the convenience to users who wish to plot or tabulate their results along with the example results, electronic versions of the example results have been included on the accompanying electronic media for Annex B8 with the file RESULTS5-2.XLS; ~~and with the following files for Annex B16: B16 with the files RESULTS5-3A.XLS, RESULTS5-3B.XLS and RESULTS5-4.XLS; and for Annex B20 with the file RESULTS7-2.XLS.~~ Documentation for navigating these results files has been included on the accompanying electronic media, and is printed in Annex B10.

4.4.1 Criteria for Determining Agreement Between Results. There are no formal criteria for when results agree or disagree. Determination of when results agree or disagree is left to the user. In making this determination, the user should consider the following:

- a. magnitude of results for individual cases,
- b. magnitude of difference in results between certain cases (e.g., “Case 610 - Case 600”),
- c. same direction of sensitivity (positive or negative) for difference in results between certain cases (e.g., “Case 610 - Case 600”),

- d. if results are logically counterintuitive with respect to known or expected physical behavior,
- e. availability of analytical or quasi-analytical solution results (i.e., mathematical truth standard as described in informative Annex B16, Section B16.2),
- f. for the space-cooling and space-heating equipment performance tests of Sections 5.3 and 5.4, the degree of disagreement that occurred for other simulation results in Annex B16 versus the quasi-analytical solution results.
- g. Example simulation results do not represent a truth standard.

4.4.2 Diagnostic Logic for Determining Causes of Differences Among Results. To help the user identify what algorithm in the tested program is causing specific differences between programs, diagnostic flow charts are provided as informational Annex B9.

4.4.3 Rules for Modifying Simulation Programs or Simulation Inputs. Modifications to simulation programs or simulation inputs shall have a mathematical, physical, or logical basis and shall be applied consistently across tests. Arbitrary modification of a simulation program's input or internal code just for the purpose of more closely matching a given set of results shall not be allowed.

If changes are made to the source code of the software for the purpose of performing tests, and these changes are not available in publicly released versions of the software, then the changes shall be documented in sufficient detail using the modeler report template provided in Annex A2, so that the implications of the changes can be assessed.

4.4.4 Discussion of Anomalous Results. At the option of the report author, anomalous test results may be explained using the modeler report template provided in Annex A2.

[Informative Note: Revise Section 5 title as shown and include introductory paragraph. Also change reference to Annex A1, Section A1.4 (to A1.5) as shown. Only existing text needed to identify changes is shown; no other changes to Section 5.]

5. CLASS I TEST PROCEDURES

Class I test procedures are detailed diagnostic tests intended for use with building energy simulation software tools having simulation time-steps of one hour or less. Energy analysis computer tools that do not meet this simulation time-step requirement but produce annual or seasonal results may be evaluated using Section 7 (Class II Test Procedures) of this standard. The Class I test cases are designed for more detailed diagnosis of simulation models than the Class II (Section 7) test cases.

5.1 Modeling Approach. This modeling approach shall apply to all the test cases presented in Sections 5.2, 5.3, and 5.4.

5.1.1 Time Convention. All references to time in this specification are to local standard time and assume that *hour 1 = the interval from midnight to 1 a.m.* Do not use daylight savings time or holidays for scheduling. TMY weather data are in hourly bins corresponding to solar time as described in Annex A1, ~~Section A1.4~~ Section A1.5. TMY2 and WYEC2 data are in hourly bins corresponding to local standard time.

[Informative Note: Revise Section 6 title as shown.]

6. CLASS I OUTPUT REQUIREMENTS

[Informative note: Normative Section 7 is all new material. Underlining is not used here.]

7. CLASS II TEST PROCEDURES

Class II test procedures may be used for all types of building load calculation methods, regardless of time-step granularity. Informative Annex B22 provides an example procedure for developing acceptance-range criteria for Section 7 test cases.

7.1 Modeling Approach. This modeling approach shall apply to all the test cases presented in Section 7.2.

7.1.1 Time Convention. All references to time in this specification are to local standard time and assume that *hour 1 = the interval from midnight to 1 a.m.* Do not use daylight savings time or holidays for scheduling. TMY weather data are in hourly bins corresponding to solar time as described in normative Annex A1, Section A1.5.

7.1.2 Geometry Convention. If the program being tested includes the thickness of walls in a three-dimensional definition of the building geometry, then wall, roof, and floor thicknesses shall be defined such that the interior air volume of the building model remains as specified. Make the thicknesses extend exterior to the currently defined internal volume.

7.1.3 Nonapplicable Inputs. In some instances the specification will include input values that do not apply to the input structure of the program being tested. When this occurs, disregard the non-applicable inputs and continue. Such inputs are in the specification for those programs that may need them.

7.1.4 Consistent Modeling Methods. Where options exist within a simulation program for modeling a specific thermal behavior, consistent modeling methods shall be used for all cases. For example, if software gives a choice of methods for modeling windows, the same window modeling method shall be used for all cases. Document the option used in the Standard Output Report (see normative Annex A2).

7.1.5 Equivalent Modeling Methods. Where a program or specific model within a program does not allow direct input of specified values, or where input of specified values causes instabilities in a program's calculations, modelers should develop equivalent inputs that match the intent of the test specification as nearly as the software being tested allows. Such equivalent inputs are to be developed based on the data provided in the test specification, and such equivalent inputs shall have a mathematical, physical, or logical basis, and shall be applied consistently throughout the test cases. The modeler shall document the equivalent modeling method in the Standard Output Report (normative Annex A2).

7.1.6 Simulation Initialization and Preconditioning. If the program being tested allows, begin the simulation initialization process with zone air conditions that equal the outdoor air conditions. If the program being tested allows for preconditioning (iterative simulation of an initial time period until

temperatures or fluxes, or both, stabilize at initial values), use that capability.

7.1.7 Simulation Duration Results for the tests of Section 7.2 are to be taken either from a full annual simulation or from a seasonal simulation(s), as allowed by the program being tested.

7.1.8 Example Acceptance-Range Criteria. For certifying or accrediting agencies that may wish to consider adopting acceptance ranges, example criteria are provided in informative Annex B22. Where application of the criteria leads to identification of a disagreement(s) that a software developer may wish to correct, the rules of Section 4.4.3 for modifying simulation programs or inputs shall be applied.

7.2 Input Specifications. The test cases are described in a manner that allows many different residential modeling tools, representing different degrees of modeling complexity, to be tested. Within this structure, figures and tables are grouped as summary data and supplemental data. The summary data, which are based on the supplemental data, are figures and tables that contain information that should cover most of the input requirements for most users. The supplemental tables contain more detailed information that was required for generating a consistent set of inputs to the programs used to generate example results provided in informative Annex B20. Such data include: material properties for modeling thermal mass and modeling the attic as a separate zone, interior solar distribution fractions, combined convective and radiative surface coefficients, hourly internal gains schedules, and detailed window optical properties. Use the supplemental data as needed, according to the inputs allowed by the tool being tested.

Apply the modeling rules of Section 7.1 for all test cases.

Abbreviations used in the tables, figures, and text, are defined in the acronyms and abbreviations of Section 3.

7.2.1 The Base Case Building (Case L100A). Begin with Case L100A. Case L100A shall be modeled as detailed in this section and its subsections.

The bulk of the work for implementing the Section 7.2 tests is assembling an accurate base building model. It is recommended that base building inputs be double-checked and results disagreements be diagnosed before going on to the other cases. Informative Annex B20 includes example simulation results for the test procedures of Section 7.

7.2.1.1 Weather Data. This case requires the use of both the Colorad.TMY and Lasvega.TMY weather data provided on the electronic media accompanying this standard, as described in normative Annex A1, Section A1.4. Colorad.TMY (a clear, cold climate) shall be used for developing heating loads, and Lasvega.TMY (a hot, dry climate) shall be used for developing cooling loads. If the program being tested uses a different representation of weather, such as degree days, bin method, etc., then the above weather data shall be processed with the tested program's weather data processor so that the tested program's output will be based on the above data.

Note: All of the Section 7 tests use the same weather data, except the following cases do not require the use of the

Lasvega.TMY data: L302A, L304A, L322A, L324A, P100A, P105A, P110A, P140A and P150A.

7.2.1.1.1 Ground Reflectance. The solar reflectance of the site ground surface = 0.2.

7.2.1.2 Output Requirements. Case L100A requires annual or seasonal heating load and sensible cooling load output as described in Section 8.1. Note: All of the Tier-1 tests (defined in Sections 7.2.1 and 7.2.2) have the same output requirements, except for cases L302A, L304A, L322A, and L324A.

7.2.1.3 Building Geometry and Material Properties. The base building plan is a 1,539 ft² floor area, single-story house with one conditioned zone (the main floor), an unconditioned attic, and a raised floor exposed to air. The following figures and tables contain information that is applicable to most users.

- Figure 7-1 Base Building Axonometric
- Figure 7-2 Floor Plan - Case L100A
- Figure 7-3 East Side Elevation - Case L100A
- Figure 7-4 Exterior Wall Plan Section - Case L100A
- Figure 7-5 Raised Floor Exposed to Air, Section - Case L100A
- Figure 7-6 Ceiling/Attic/Roof Section - Case L100A
- Figure 7-7 Interior Wall Plan Section - Case L100A
- Figure 7-8 Window Detail, Vertical Slider (NFRC AA) with 2-3/4" Wide Frame - Case L100A
- Table 7-1 Building Thermal Summary - Case L100A
- Table 7-2 Other Building Details - Case L100A.

Relevant supplementary tables that include more detailed information are:

- Table 7-3 Component Surface Areas and Solar Fractions - Case L100A
- Table 7-4 Material Descriptions, Exterior Wall, Door and Window - Case L100A
- Table 7-5 Material Descriptions, Raised Floor Exposed to Air - Case L100A
- Table 7-6 Material Descriptions, Ceiling, Attic and Roof - Case L100A
- Table 7-7 Material Descriptions, Ceiling/Attic/Roof, Attic as Material Layer - Case L100A (for calculating equivalent ceiling/attic/roof composite R-value.)
- Table 7-8 Material Descriptions, Interior Wall - Case L100A
- Table 7-9 Internal Loads Schedule - Case L100A
- Table 7-10 Window Summary, Single Pane Aluminum Frame with Thermal Break - Case L100A
- Table 7-11 Glazing Summary, Single Pane Center of Glass Values - Case L100A
- Table 7-12 Optical Properties as a Function of Incidence Angle for Single-Pane Glazing - Case L100A.

Other details not described in these figures and tables are discussed topically in the following subsections.

7.2.1.4 Attic. Many residential energy analysis tools input an attic by specifying it within a menu of roof types, and then specifying the insulation-only R-value corresponding to the insulation installed on the attic floor. If this is the case for the software being tested, then the information provided in Figure 7-6 will be sufficient.

For programs such as those used for developing the example results, more detailed information is required. The detailed information for modeling an attic as a separate zone is supplied in Table 7-6. Table 7-7 gives similar information as Table 7-6, except in Table 7-7 the attic space is modeled as a layer of thermal resistance between ceiling and roof materials. Table 7-7 is included to document the calculation of ceiling/attic/roof composite air-air R-value noted in the building thermal summary of Table 7-1. In Table 7-7, the equivalent resistance for the attic is based on values from the Cooling and Heating Load Calculation Manual;^{B-3} typical ventilation by natural effects and roof solar absorptance of 0.6 were assumed. The equivalence of the one-zone model versus the two-zone base case was verified with sensitivity tests using BLAST and SERIRES/SUNCODE.^{B-4, B-5}

As with other components, except where explicitly varied by the test specification, the attic must be modeled consistently for all test cases such that the modeling rules of Section 7.1 are applied.

7.2.1.5 Raised Floor Exposed to Air. To simulate a raised floor exposed to air, the test cases require the following assumptions:

- air temperature below raised floor is assumed to equal outdoor air temperature
- the underside of the conditioned-zone floor has an exterior film coefficient of 2.2 Btu/(h·ft²·°F), consistent with a "rough" surface texture and zero windspeed; if the program being tested cannot set the exterior surface coefficient to a fixed value, then allow exterior surface coefficient to vary with wind speed.
- the conditioned-zone floor exterior surface (surface facing the raised floor) receives no solar radiation.

The assumption of the air temperature below the raised floor being equal to ambient temperature may be approximated either by modeling a building that is hovering 10 feet or more above the ground (raised floor on stilts for example), or modeling a very highly ventilated crawl space. The zero solar-radiation-to-exterior-floor assumption can be modeled by assigning the highest solar reflectance allowed by the software being tested to the underside of the floor and/or defining shading planes where walls would be if the raised floor were modeled as a crawl space.

7.2.1.6 Interior Walls. The interior walls within the conditioned zone have been included for the purpose of modeling the effect of their mass. They are not intended to divide the conditioned zone into separately controlled zones.

7.2.1.7 Infiltration. Infiltration rates are specified in Table 7-2. The Colorad.TMY and Lasvega.TMY climate sites are at 6145 ft and 2178 ft altitude, respectively, so the density of air is less than that at sea-level for both locations. If the program being tested does not use barometric pressure from the weather data, or otherwise does not automatically correct for the change in air density caused by altitude, then adjust the specified infiltration rates (to yield mass flows equivalent to what would occur at the specified altitude) as shown in Table 7-2. The listed infiltration rate is independent of wind speed, indoor/outdoor temperature difference, etc. Only use the attic

infiltration rate if the software being tested allows that input. Attic infiltration is based on the *Cooling and Heating Load Calculation Manual*^{B-3} for typical ventilation by natural effects. The calculation technique used for developing altitude effects on infiltration is included in informative Annex B3.

7.2.1.8 Internal Loads. These are non-HVAC related internally generated loads from equipment, lights, people, animals, etc. Use the hourly internal load schedule for the conditioned zone specified in Table 7-9. This schedule disaggregates sensible and latent loads. There are no internal loads in the attic. If the software being tested does not analyze latent loads, then leave them out and use only the sensible portion of the internal loads.

Aggregate sensible loads are 70% radiative and 30% convective.

Because internal loads are given only for their effect on heating and cooling load, the equipment fuel type and efficiency associated with generating these loads do not matter.

7.2.1.9 Combined Radiative and Convective Surface Coefficients. If the program being tested does not allow variation of combined surface coefficients, or if it automatically calculates interior and exterior surface convection and radiation, then this section may be disregarded.

Combined surface coefficients are denoted in various section drawings throughout Section 7 as "Interior Film" and "Exterior Film" (e.g., see Figures 7-4 through 7-7). If the program being tested uses combined surface coefficients, then use the information given in Table 7-2 (this information is also included with the detailed material descriptions of Tables 7-4 through 7-8, 7-10, and 7-11). Because the heating season average windspeed for Colorad.TMY weather data is nearly equal to the cooling season average windspeed for Lasvega.TMY data, the listed exterior surface coefficients apply to both climates.

See informative Annex B4 and informative Annex B5 for more information on surface coefficients.

7.2.1.10 Opaque Surface Radiative Properties. Surface radiative properties are given in Table 7-2. These properties apply to all opaque exterior and interior building surfaces; they are roughly equivalent to medium color paint or a light color roof.

7.2.1.11 Windows. A great deal of information about the window properties has been provided so that equivalent input for windows is possible for many programs. Use only the information that is relevant to the program being tested. The basic properties of the single-pane window, including shading coefficient, solar heat gain coefficient, and thermal resistance, are provided in Table 7-1. Additional information is included in Figure 7-8, Table 7-4, and Tables 7-10 through 7-12. This information is drawn primarily from the WINDOW 4.1 software^{B-6} for developing detailed glazing properties. For programs that need transmittance or reflectance at other angles of incidence, interpolate between the values of Table 7-12 using the cosine of the incidence angle as the basis of interpolation. Where other unspecified data are needed, then values that are consistent with those quoted must be calculated.

For the base case, total glass and frame areas for each wall may be combined into a single large area for that wall. For later cases where shading is used, the specific window geometry must be modeled as closely as possible.

7.2.1.12 Interior Solar Distribution. If the program being tested does not allow for variations of interior solar distribution, then this section may be disregarded. Interior solar distribution is the fraction of transmitted solar radiation incident on specific surfaces in a room. If the program being tested does not calculate this effect internally, then use the interior solar fractions from Table 7-3. The calculation of transmitted solar radiation reflected back out through windows (cavity albedo) is presented in informative Annex B7, Section B7.2.

7.2.1.13 Mechanical System. This mechanical system only applies to the conditioned zone; it does not apply to the unconditioned attic. The intent of the mechanical system is to produce only pure heating load and sensible cooling load outputs. That is, all equipment is 100% efficient with no duct losses and no capacity limitations. The mechanical system shall be modeled with the following features as noted below and in Sections 7.2.1.14 and 7.2.1.15:

- 100% convective air system
- the thermostat senses only the air temperature
- nonproportional type thermostat (see Section 7.2.1.14)
- no latent heat extraction.

7.2.1.14 Thermostat Control Strategies. Annual thermostat control settings are shown below. Heating and cooling seasons shall be for either the entire year or some other reasonable length as designated by the program being tested.

For Colorad.TMY weather data (heating only)

HEAT = ON IF TEMP < 68°F; COOL = OFF.

For Lasvega.TMY weather data (cooling only):

COOL = ON IF TEMP > 78°F; HEAT = OFF.

Note: "TEMP" refers to conditioned zone air temperature.

The thermostat is nonproportional in the sense that when the conditioned-zone air temperature exceeds the thermostat cooling set-point, the heat extraction rate is assumed to equal the maximum capacity of the cooling equipment. Likewise, when the conditioned-zone air temperature drops below the thermostat heating set-point, the heat addition rate equals the maximum capacity of the heating equipment. A proportional thermostat throttles the heat addition rate (or extraction rate) in proportion to the difference between the zone setpoint temperature and the actual zone temperature. If the program being tested requires the use of a proportional thermostat, a proportional thermostat model can be made to approximate a nonproportional thermostat model by setting a very small throttling range (the minimum allowed by the program being tested).

7.2.1.15 Equipment Characteristics.

HEATING CAPACITY = 3.413 million Btu/h
(effectively infinite).

EFFECTIVE EFFICIENCY = 100%.

COOLING CAPACITY = 3.413 million Btu/h
(effectively infinite).

EFFECTIVE EFFICIENCY = 100%

Sensible Cooling only; no latent heat load calculation.

WASTE HEAT FROM FAN = 0.

The 3.413 million Btu/h requirement comes from the I-P units equivalent of 1 MW. If the software being tested does not allow this much capacity, then use the largest system that the software being tested will allow.

Equipment efficiency is always 100% independent of part loading, indoor dry-bulb temperature and humidity ratio, outdoor dry-bulb temperature and humidity ratio, and/or other conditions.

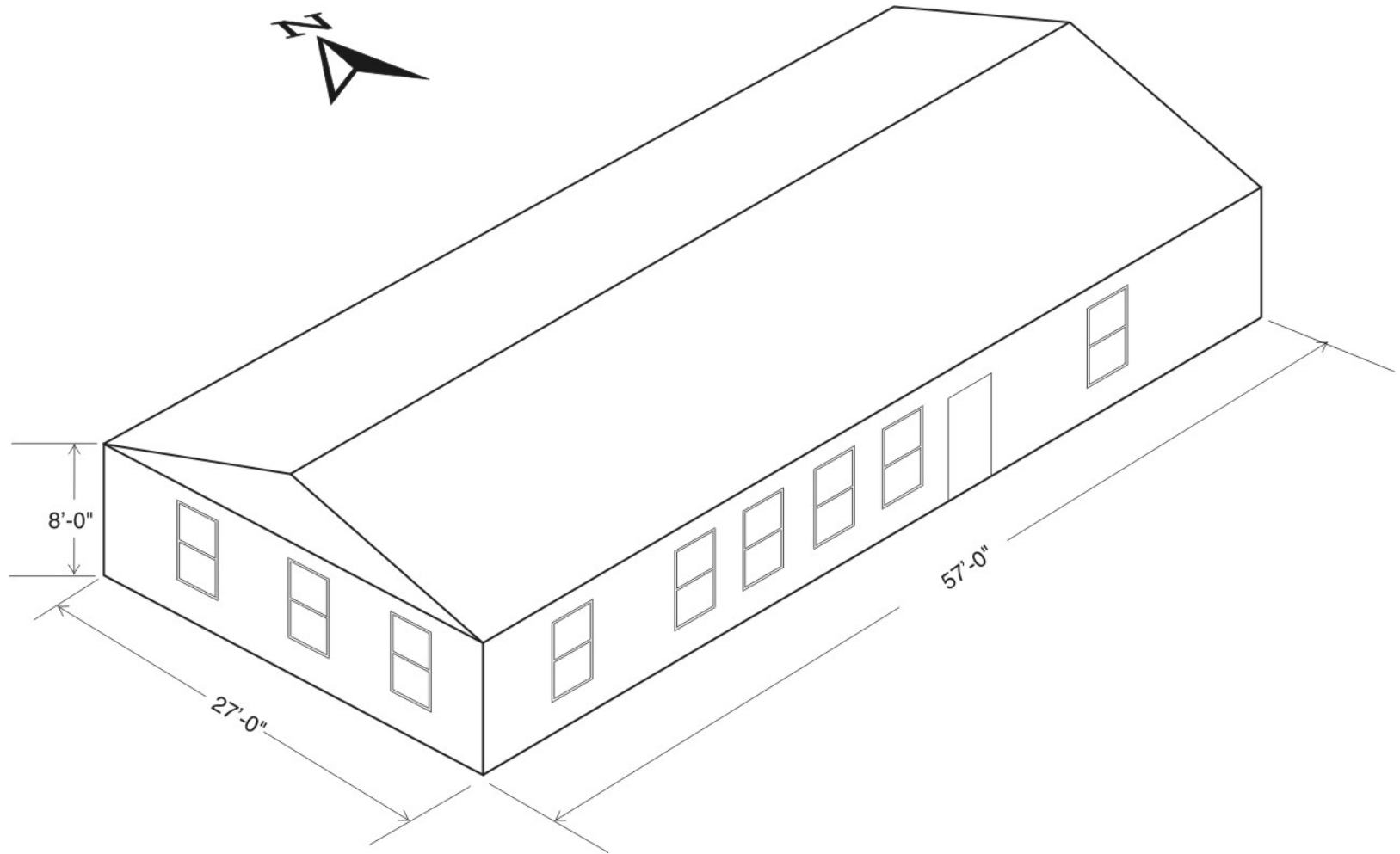
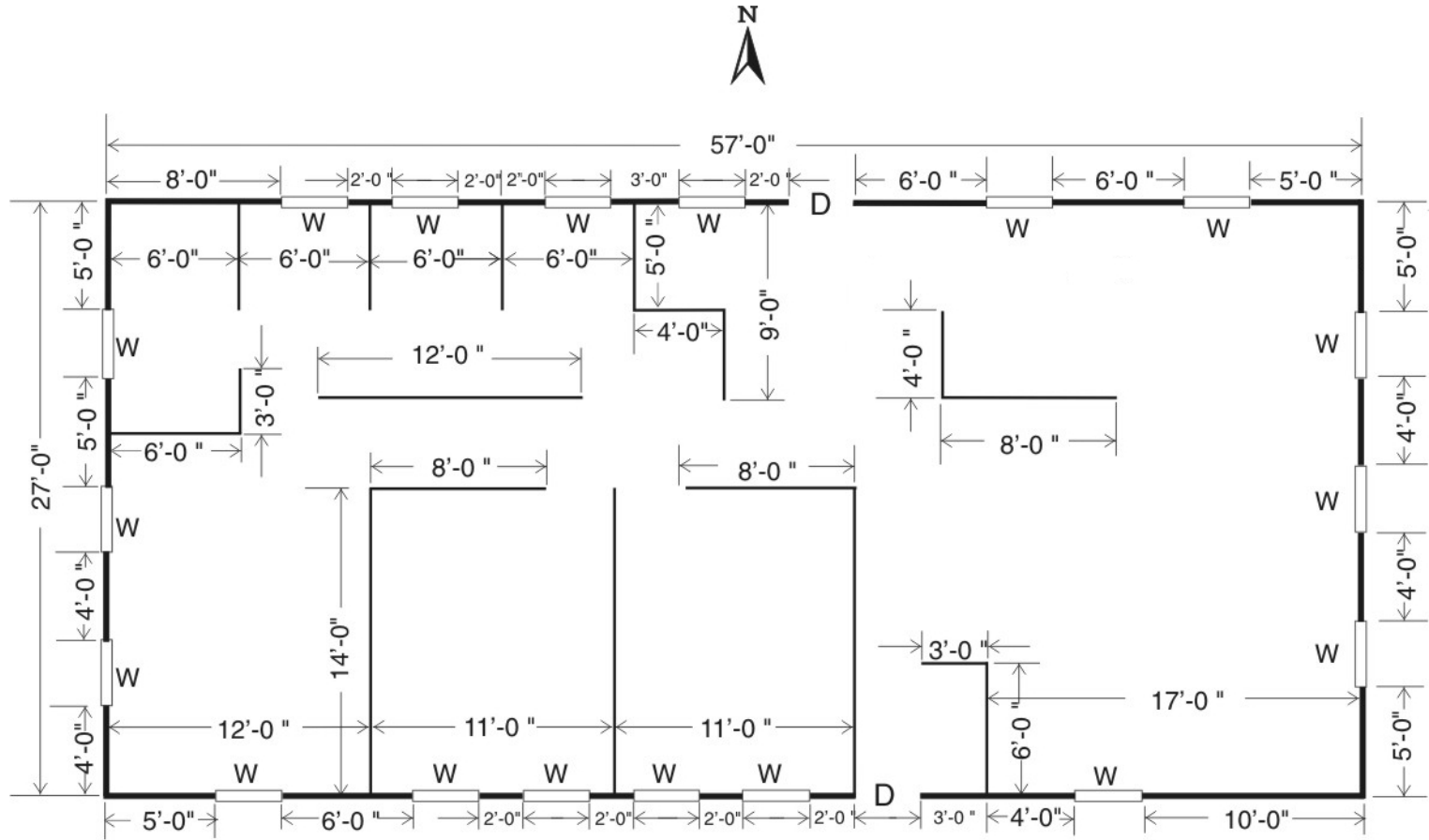

Figure 7-1 Base building axonometric.



Note: To match the interior wall length and corresponding interior wall area listed in Table 7-3, a 9 ft length of interior wall was removed (versus the original HERS BESTEST floor plan).

CD-RH06-A0327301

Legend:

- W = Window (3' wide × 5' high), see Figure 7-8
- D = Solid-core wood door (3' wide × 6'8" high)

Figure 7-2 Floor plan—Case L100A.

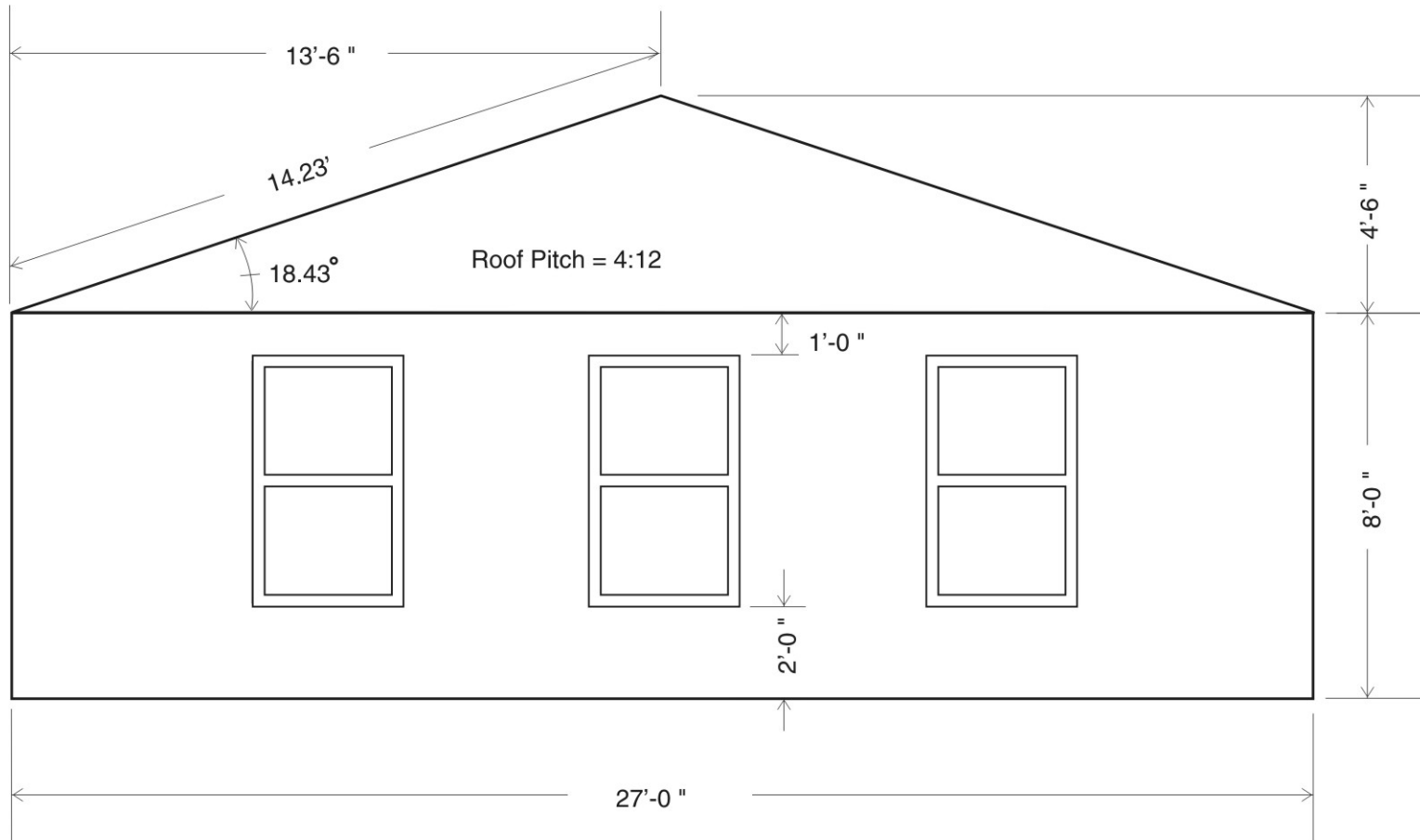

CD-RH06-A0327302

Note: All windows located vertically as shown; see Figure 7-8 for window detail.

Figure 7-3 East side elevation—Case L100A.

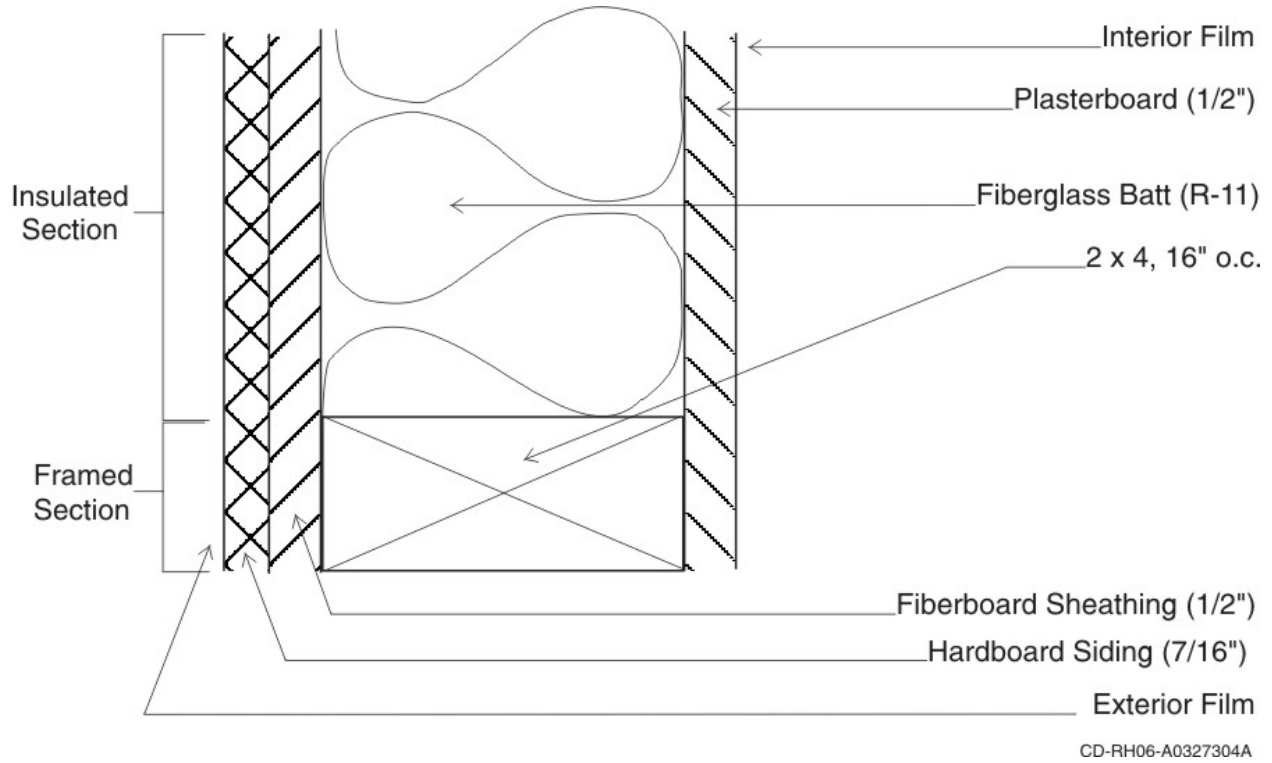

Figure 7-4 Exterior wall plan section—Case L100A.

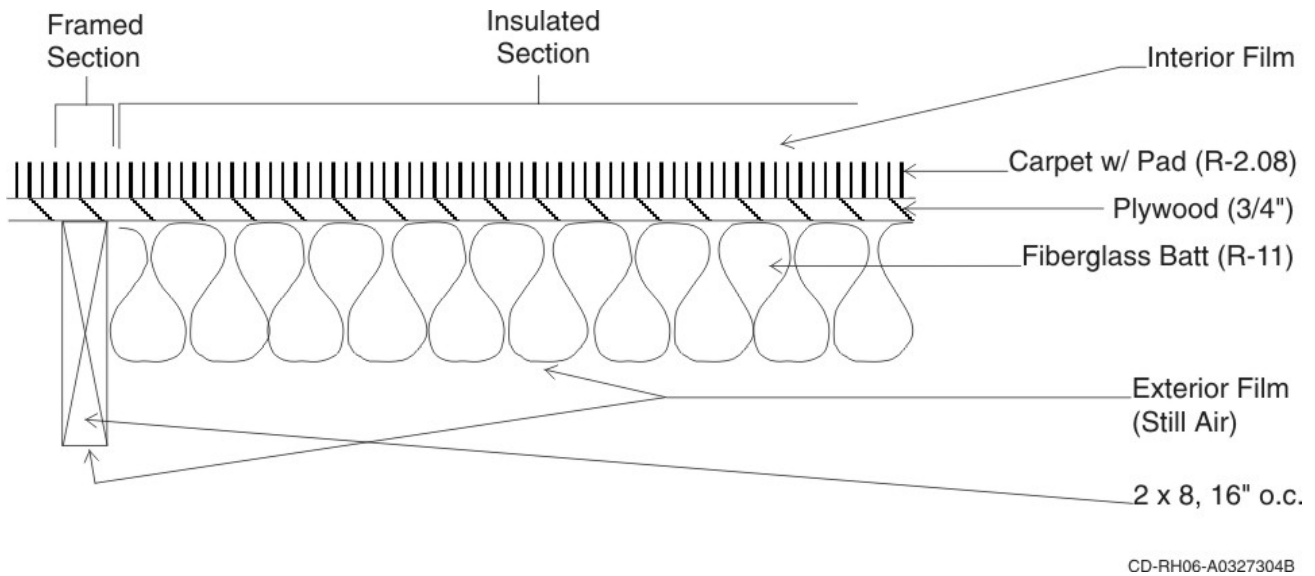
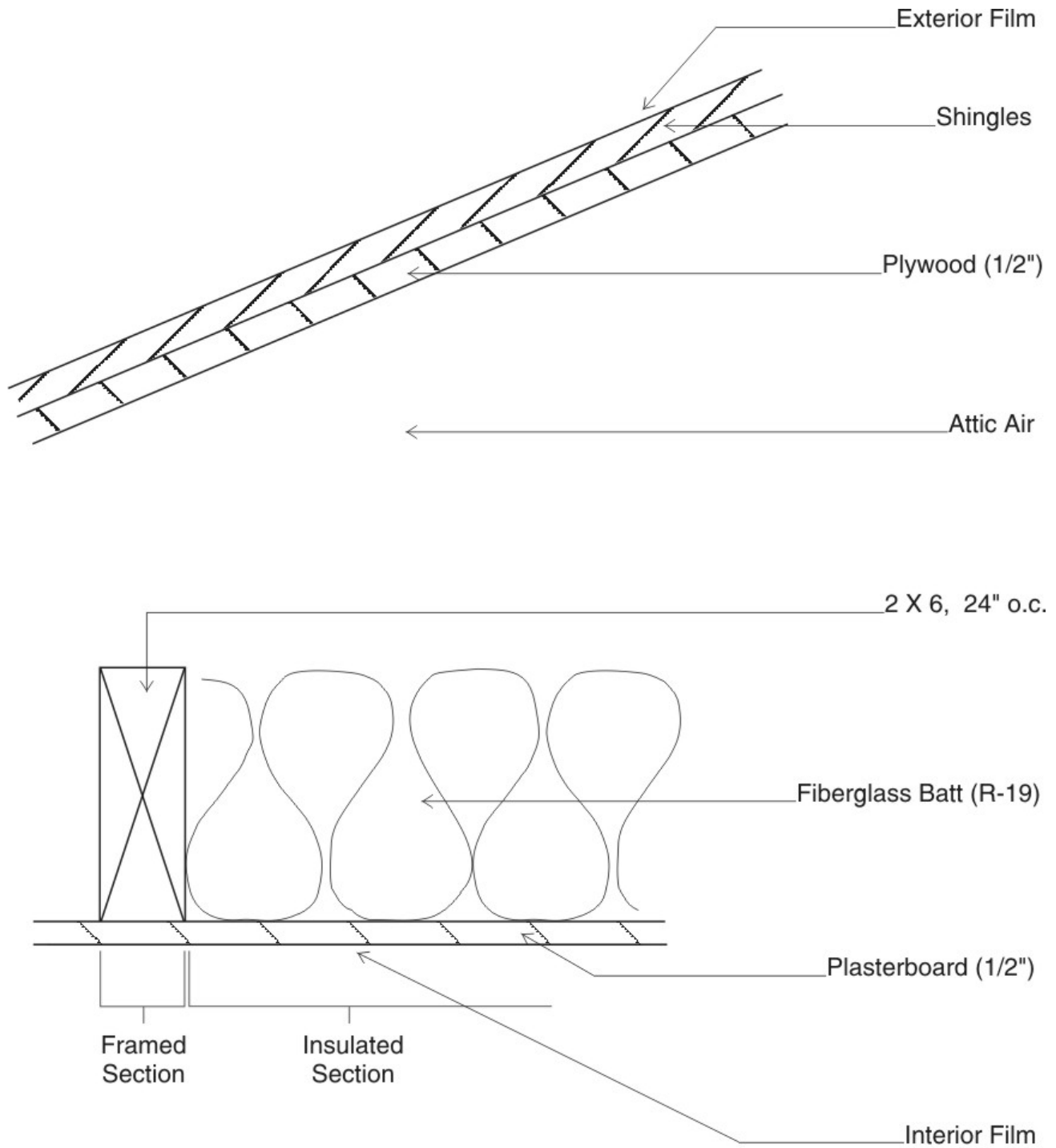
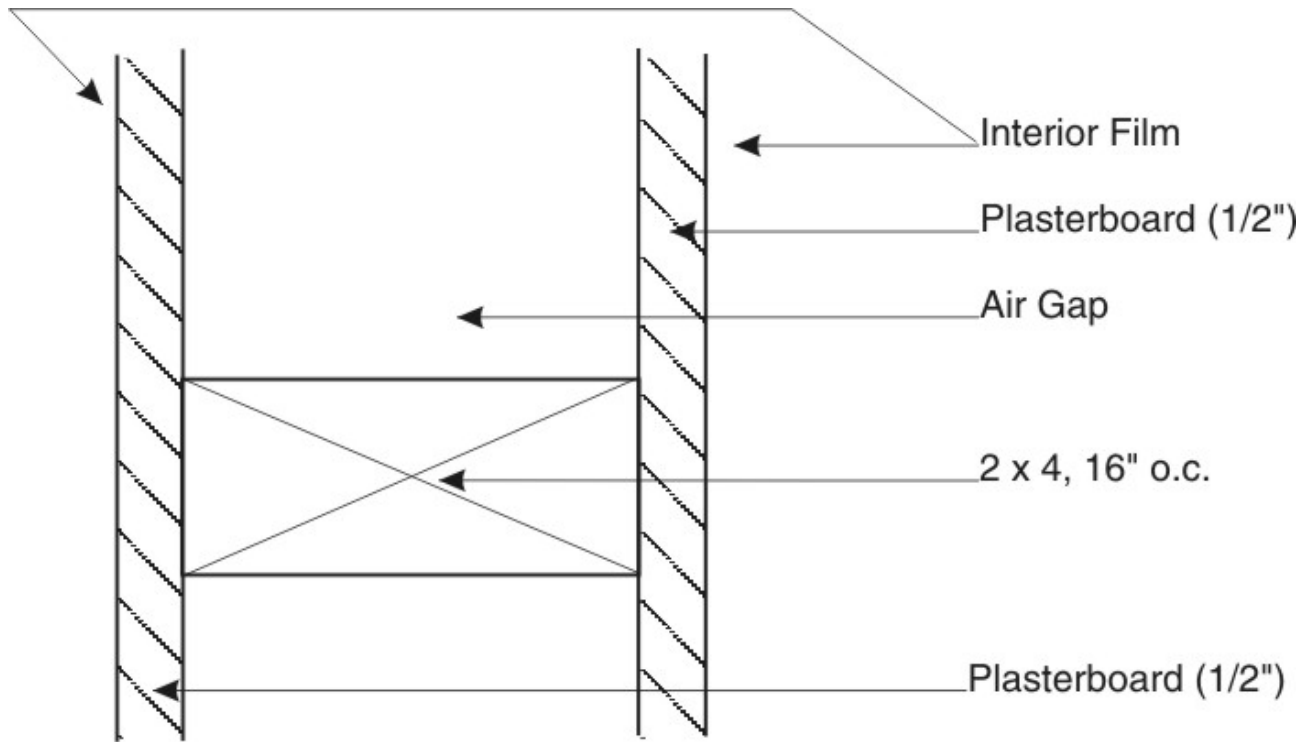

Figure 7-5 Raised floor exposed to air, section—Case L100A.



CD-RH06-A0327305

Figure 7-6 Ceiling/attic/roof section—Case L100A.



CD-RH06-A0327323

Figure 7-7 Interior wall plan section—Case L100A.

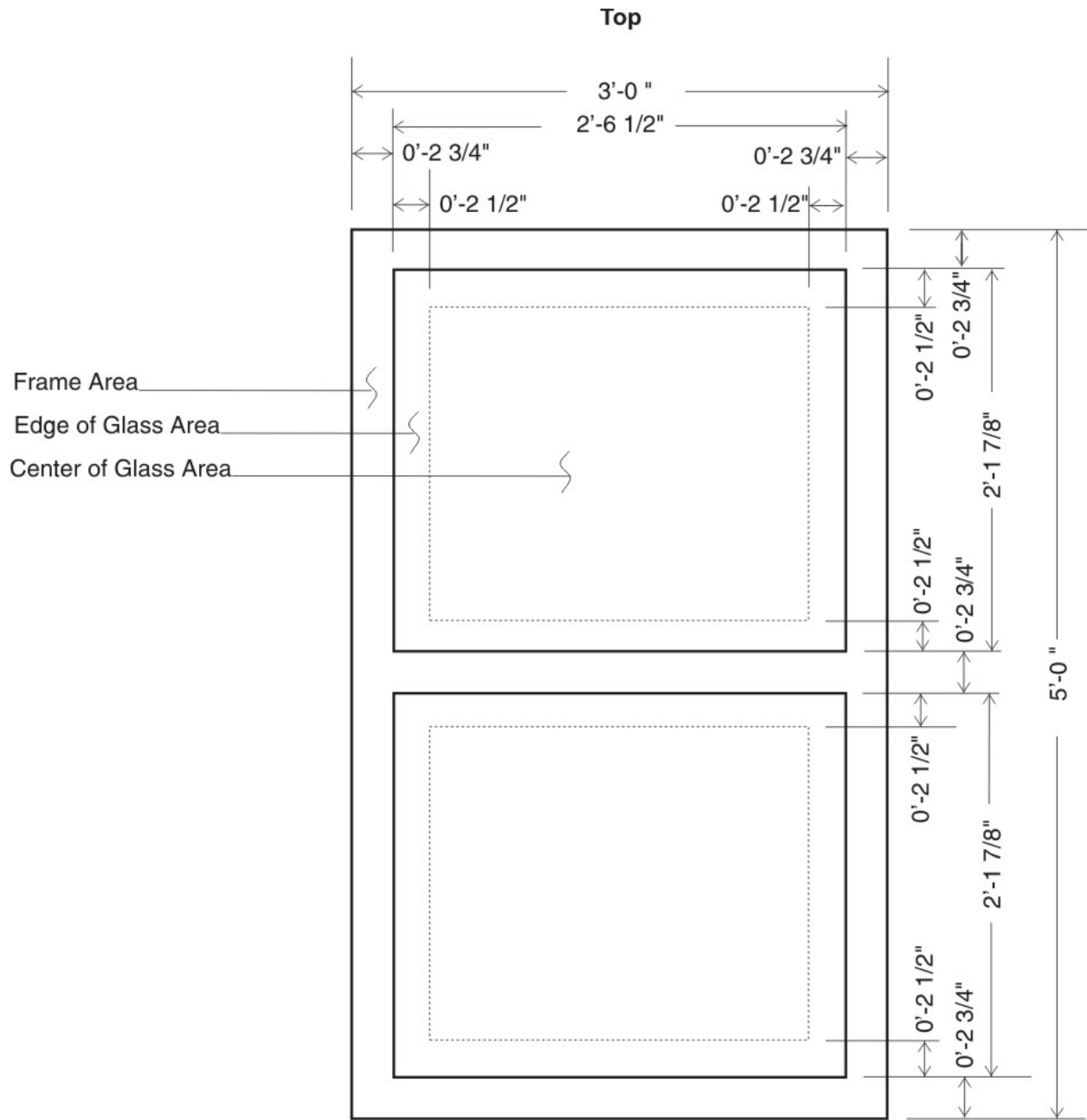

CD-RH06-A0327303

Figure 7-8 Window detail, vertical slider (NFRC AA) with 2 3/4" wide frame—Case L100A.

TABLE 7-1 Building Thermal Summary—Case L100A

ELEMENT	Area ft ²	R h·ft ² ·°F/Btu (Note 1)	U Btu/(h·ft ² ·°F) (Note 1)	UA Btu/(h·°F) (Note 1)	HEATCAP Btu/F (Note 2)
Exterior Walls (Note 3)	1034	11.76	0.085	87.9	1383
North Windows (Note 4)	90	0.96	1.039	93.5	
East Windows (Note 4)	45	0.96	1.039	46.7	
West Windows (Note 4)	45	0.96	1.039	46.7	
South Windows (Note 4)	90	0.96	1.039	93.5	
Doors	40	3.04	0.329	13.2	62
Ceiling/Attic/Roof (Note 5)	1539	20.48	0.049	75.1	1665
Floor (Note 5)	1539	14.15	0.071	108.8	1471
Infiltration (Note 6)					
Colorado Springs, CO (Colorad.TMY)				118.2	
Las Vegas, NV (Lasvega.TMY)				136.9	
Interior Walls	1024				1425
TOTAL BUILDING					6006
Excluding Infiltration				565.5	
Including Infiltration (Colorado Springs, CO)				683.7	
Including Infiltration (Las Vegas, NV)				702.4	

WINDOW SUMMARY: SINGLE PANE, ALUMINUM FRAME WITH THERMAL BREAK

(Note 7)	Area ft ²	U Btu/(h·ft ² ·°F) (Note 1)	SHGC (dir. nor.) (Note 8)	Trans. (dir. nor.) (Note 9)	SC (Note 10)
Glass pane	10.96	1.064	0.857	0.837	1.000
Aluminum sash with thermal break	4.04	0.971			
Window, composite	15.00	1.039	0.670	0.612	0.781

Note 1: Includes interior and exterior surface coefficients.

Note 2: Heat capacity includes building mass within the thermal envelope (e.g., insulation and insulation thickness of structural framing are included, exterior siding and roof/attic mass are excluded).

Note 3: Excludes area of windows and doors. ASHRAE framed area fraction of 0.25 is assumed for 2x4 16" O.C. construction.

Note 4: Window area and other properties are for glass and frame combined. The accompanying window summary disaggregates glass and frame properties for a single window unit. North and south walls contain six window units each; east and west walls contain three window units each.

Note 5: ASHRAE roof/ceiling framing area fraction of 0.1 applied to both ceiling and floor.

Note 6: Infiltration UA = (infiltration mass flow) × (specific heat). Assumes air properties: specific heat = 0.240 Btu/(lb·°F); density = 0.075 lb/ft³ at sea level, adjusted for altitude per informative Annex B3, Section B3.3. The following values were used to obtain infiltration UA:

Location	ACH	Volume (ft ³)	Altitude (ft)	UA _{inf} (Btu/(h·°F))
Colorado Springs	0.67	12312	6145	118.2
Las Vegas	0.67	12312	2178	136.9

Note 7: This data summarizes one complete window unit per detailed description of Figure 7-8 and Tables 7-10 through 7-12.

Note 8: SHGC is the Solar Heat Gain Coefficient that includes the inward flowing fraction of absorbed direct normal solar radiation in addition to direct normal transmittance. For more detail, see ASHRAE 1993 Fundamentals, chapter 27 (Reference B-7).

Note 9: "Trans." is the direct normal transmittance.

Note 10: Shading coefficient (SC) is the ratio of direct normal SHGC for a specific glazing unit to direct normal SHGC for the WINDOW 4.1 reference glazing unit.

TABLE 7-2 Other Building Details—Case L100A

	Conditioned Zone		Attic (unconditioned)	
	ACH	CFM	ACH	CFM
AIR VOLUME (ft³)	12312		3463	
INFILTRATION	ACH	CFM	ACH	CFM
Tools w/ automatic altitude adjustment	0.670	137.5	2.400	138.5
Tools w/ site fixed at sea level (Note 1)				
Colorado Springs, CO	0.533	109.4	1.910	110.2
Las Vegas, NV	0.618	126.8	2.213	127.7
INTERNAL GAINS	Sensible	Latent	Sensible	Latent
Daily internal gains (Btu/day)	56105	12156	0.0	0.0
(see Table 7-9 for hourly profile)				
COMBINED RADIATIVE AND CONVECTIVE SURFACE (FILM) COEFFICIENTS				
(Note 2)	Exterior film U-val		Interior film U-val	
	Btu/(h·ft ² ·°F)		Btu/(h·ft ² ·°F)	
Walls and doors	5.748		1.460	
Ceiling	n/a		1.307	
Roof	5.748		1.330	
Raised floor exposed to air	2.200		1.307	
Window	4.256		1.460	
Window frame	4.256		1.460	
SURFACE RADIATIVE PROPERTIES	Exterior		Interior	
Shortwave (visible and UV) absorptance	0.600		0.600	
Longwave (infrared) emittance	0.900		0.900	

Note 1: Informative Annex B3 describes the algorithm used for adjusting infiltration rates if the software being tested does not account for variation of air density with altitude (i.e., site fixed at sea level).

Note 2: More information about combined surface coefficients is included in informative Annexes B4 and B5.

TABLE 7-3 Component Surface Areas and Solar Fractions—Case L100A

ELEMENT	HEIGHT or		MULTIPLIER	AREA	INSIDE	
	LENGTH	WIDTH			SOLAR	FRACTION
	ft	ft		ft ²		
EXT. NORTH/SOUTH WALLS					(Note 1)	
Gross Wall	8.0	57.0	1.0	456.0		
Gross Window	5.0	3.0	6.0	90.0		
Window Frame Only				24.2	0.0031	
Door	6.67	3.0	1.0	20.0	0.0026	
Net Wall (Note 2)				346.0		
Insulated Wall (Note 2)				259.5	0.0332	
Framed Wall (Note 2)				86.5	0.0111	
EXTERIOR EAST/WEST WALLS						
Gross Wall	8.0	27.0	1.0	216.0		
Gross Window	5.0	3.0	3.0	45.0		
Window Frame Only				12.1	0.0016	
Net Wall (Note 2)				171.0		
Insulated Wall (Note 2)				128.3	0.0164	
Framed Wall (Note 2)				42.8	0.0055	
INTERIOR WALLS						
Gross Wall (Note 3)	8.0	128.0		1024.0		
Unframed Wall (Note 3)				921.6	0.1179	
Framed Wall (Note 3)				102.4	0.0131	
FLOOR/CEILING						
Gross Floor/Ceiling	57.0	27.0	1.0	1539.0		
Insulated Floor/Ceiling (Note 4)				1385.1	0.1772	
Framed Floor/Ceiling (Note 4)				153.9	0.0197	
ROOF						
Roof Deck (Note 5)	57.0	14.2	2.0	1622.2		
Attic E/W Gable (Note 6)	4.5	27.0	2.0	121.5		
TRANSMITTED SOLAR, INTERIOR DISTRIBUTION SUMMARY						
Total Opaque Interior Surface Area (Note 7)				6272.7	0.8024	
Solar to Air (or low mass furnishings)					0.1750	(Note 8)
Solar Lost (back out through windows)					0.0226	(Note 9)

Note 1: Solar energy transmitted through windows is assumed as distributed to interior opaque surfaces in proportion to their areas. Only the radiation not directly absorbed by light-weight furnishings (assumed to exist only for the purpose of calculating inside solar fraction) or not lost back out through windows is distributed to interior opaque surfaces.

Note 2: Net wall area is gross wall area less the rough opening areas of the windows and door. Insulated and framed exterior wall sections are defined in Figure 7-4. ASHRAE framed area fraction of 0.25 is assumed for 2x4 16" O.C. construction.

Note 3: Width is the total length of all interior walls. Framed wall area is assumed to be 10% of gross wall area for 2x4 16" O.C. framing. Only one side of the wall is considered for listed area. This area is multiplied by 2 for determining solar fractions. Solar fractions shown are for just one side of the interior wall.

Note 4: Insulated and framed floor and ceiling sections are defined in Figures 7-5 and 7-6 respectively. ASHRAE roof/ceiling framing area fraction of 0.1 applied to both ceiling and floor.

Note 5: The multiplier accounts for both the northward and southward sloped portions of the roof deck.

Note 6: Gable area is calculated as a triangle. Multiplier accounts for east- and west-facing gable ends.

Note 7: Total area of just those surfaces to which an inside solar fraction is applied.

Note 8: Based on the midpoint of the range given by SUNCODE-PC User's Manual, p. 2-16.

Note 9: Calculated using the algorithm described in informative Annex B7, Section B7.2.

TABLE 7-4 Material Descriptions Exterior Wall, Door, Window—Case L100A

EXTERIOR WALL (inside to outside)

ELEMENT	Thickness in.	R h·ft ² ·°F/ Btu	U Btu/ (h·ft ² ·°F)	k Btu/ (h·ft·°F)	DENSITY lb/ft ³	Cp Btu/(lb·°F)
Int Surf Coef		0.685	1.460			
Plasterboard	0.5	0.450	2.222	0.0926	50.0	0.26
Fiberglass batt (Note 1)	3.5	11.000	0.091	0.0265	0.6	0.20
Frame 2x4, 16" O.C. (Note 2)	3.5	4.373	0.229	0.0667	32.0	0.33
Fiberboard sheathing	0.5	1.320	0.758	0.0316	18.0	0.31
Hardboard siding, 7/16"	0.44	0.670	1.492	0.0544	40.0	0.28
Ext Surf Coef (Note 3)		0.174	5.748			
Total air - air, insulated section		14.299	0.070			
Total air - air, frame section		7.672	0.130			
Total air - air, composite section (Note 4)		11.760	0.085			
Total surf - surf, insulated section		13.440	0.074			
Total surf - surf, frame section		6.813	0.147			
Total surf - surf, composite section (Note 5)		10.901	0.092			

DOOR

Solid core door	1.75	2.179	0.459	0.0669	32.0	0.33
Total air - air, door only (Note 6)		3.038	0.329			

WINDOW SUMMARY: SINGLE PANE, ALUMINUM FRAME WITH THERMAL BREAK

(Note 7)	Thickness in.	Area ft ²	R h·ft ² ·°F/ Btu	U Btu/ (h·ft ² ·°F)	SHGC (dir. nor.)	Trans. (dir. nor.)	SC
ELEMENT (Source)					(Note 8)	(Note 9)	(Note 10)
Int surf coef, glass			0.685	1.460			
Int surf coef, frame			0.685	1.460			
Glass pane	0.118	10.96	0.020	49.371	0.857	0.837	1.000
Aluminum sash w/ thermal break		4.04	0.110	9.096			
Ext surf coef (Note 11)			0.235	4.256			
Window composite air-air		15.00	0.963	1.039	0.670	0.612	0.781

Note 1: Insulated section only, see Figure 7-4 for section view of wall.

Note 2: Framed section only, see Figure 7-4 for section view of wall.

Note 3: 10.7 mph wind speed and brick/rough plaster roughness assumed; see informative Annexes B4 and B5 for more information about exterior film coefficients.

Note 4: Total composite R-values based on 75% insulated section 25% frame area section per ASHRAE. Thermal properties of windows and doors are not included in this composite calculation.

Note 5: Total surf-surf composite R-value is the total air-air composite R-value less the resistances due to the film coefficients.

Note 6: Door has same film coefficients as exterior wall.

Note 7: This section summarizes the detailed window description of Tables 7-10 through 7-12. Areas pertain to one complete window unit only (see Figure 7-8). If the software being tested is capable of modeling windows in greater detail than shown here, then use Tables 7-10 through 7-12.

Note 8: SHGC is the Solar Heat Gain Coefficient, which includes the inward flowing fraction of absorbed direct normal solar radiation in addition to direct normal transmittance. For more detail, see ASHRAE 1993 Fundamentals, chp. 27 (Reference B-7).

Note 9: "Trans." is the direct normal transmittance.

Note 10: Shading coefficient (SC) is the ratio of direct normal SHGC for a specific glazing unit to direct normal SHGC for the WINDOW 4.1 reference glazing unit.

Note 11: Exterior surface coefficient is the same for both frame and glass; see informative Annexes B4 and B5 for more about exterior film coefficients.

TABLE 7-5 Material Descriptions, Raised Floor Exposed to Air—Case L100A

RAISED FLOOR EXPOSED TO AIR (inside to outside)						
ELEMENT	Thickness in.	R h·ft ² ·°F/Btu	U Btu/(h·ft ² ·°F)	k Btu/(h·ft·°F)	DENSITY lb/ft ³	Cp Btu/(lb·°F)
Int Surf Coef (Note 1)		0.765	1.307			
Carpet w/ fibrous pad (Note 2)		2.080	0.481			0.34
Plywood 3/4"	0.75	0.937	1.067	0.0667	34.0	0.29
Fiberglass batt (Note 3)	3.5	11.000	0.091	0.0265	0.6	0.20
Joists 2x8, 16" O.C. (Note 4)	3.5	4.373	0.229	0.0667	32.0	0.33
Ext Surf Coef (Note 5)		0.455	2.200			
Total air-air, insulated section		15.237	0.066			
Total air-air, frame section		8.609	0.116			
Total air-air, composite section (Note 6)		14.148	0.071			
Total surf-surf, composite section (Note 7)		12.928	0.077			

Note 1. Average of ASHRAE heating and cooling coefficients.

Note 2. There is not enough information available for modeling thermal mass of carpet.

Note 3. Insulated sections only, see Figure 7-5 for section view of floor.

Note 4. Framed section only, see Figure 7-5 for section view of floor. For modeling purposes, thickness is the same as for insulation; remaining length is assumed to be at ambient air temperature and is not considered as thermal mass.

Note 5. Still air and brick/rough plaster roughness assumed; see informative Annex B4 for exterior film coefficient as a function of wind speed and surface roughness. This coefficient is applied to the 1539 ft² floor area.

Note 6. ASHRAE roof/ceiling framing area fraction of 0.1 applied.

Note 7. Total air-air composite R-value less the film resistances.

TABLE 7-6 Material Descriptions, Ceiling, Attic, and Roof—Case L100A

CASE L100: CEILING/ATTIC/ROOF (inside to outside), attic as unconditioned zone

(Note 1) ELEMENT	Thickness in.	R h·ft ² ·°F/Btu	U Btu/(h·ft ² ·°F)	k Btu/(h·ft·°F)	DENSITY lb/ft ³	C _p Btu/(lb·°F)
CEILING (1539 ft² total area)						
Int Surf Coef (Note 2)		0.765	1.307			
Plasterboard	0.5	0.450	2.222	0.0926	50.0	0.26
Fiberglass batt (Note 3)	6.25	19.000	0.053	0.0274	0.6	0.20
Joists 2x6, 24" O.C. (Note 4)	5.5	6.872	0.146	0.0667	32.0	0.33
Int Surf Coef (Note 2)		0.765	1.307			
Total air-air, insulated section		20.980	0.048			
Total air-air, framed section		8.852	0.113			
Total air-air, composite section (Note 5)		18.452	0.054			
Total surf - surf, composite section (Note 5)		16.922	0.059			
END GABLES (121.5 ft² total area)						
Int Surf Coef		0.685	1.460			
Plywood 1/2"	0.5	0.625	1.601	0.0667	34.0	0.29
Hardboard siding, 7/16"	0.44	0.670	1.492	0.0544	40.0	0.28
Ext Surf Coef (Note 6)		0.174	5.748			
Total air-air		2.154	0.464			
ROOF (1622 ft² total area)						
Int Surf Coef (Note 7)		0.752	1.330			
Plywood 1/2"	0.5	0.625	1.601	0.0667	34.0	0.29
Asphalt shingle 1/4"	0.25	0.440	2.273	0.0473	70.0	0.30
Ext Surf Coef (Note 6)		0.174	5.748			
Total air-air		1.991	0.502			

Total Roof/Gable UA, surf-surf (Note 8) 1711 Btu/(h·°F)

Note 1: This table is for modeling the attic as a separate zone.

Note 2: Average of ASHRAE heating and cooling coefficients, horizontal surface.

Note 3: Insulated section only, see Figure 7-6 for section view of ceiling.

Note 4: Framed section only, see Figure 7-6 for section view of ceiling.

Note 5: Based on 10% frame area fraction per ASHRAE; applies to temperature difference between room air and attic air. The "composite surf-surf" R-value is the composite air-air R-value less the two interior film coefficient R-values.

Note 6: 10.7 mph wind speed and brick/rough plaster roughness assumed; see informative Annex B4 for more about exterior film coefficients.

Note 7: Average for ASHRAE upward and downward heat flow through sloped surface, interpolated on cosine of roof pitch angle.

Note 8: Area weighted sum of plywood and asphalt shingle or wood siding material layers, does not include film coefficients. This value used for developing Table 7-7.

TABLE 7-7 Material Descriptions, Ceiling/Attic/Roof, Attic as Material Layer—Case L100A

COMPOSITE CEILING/ATTIC/ROOF (inside to outside)						
ELEMENT	Thickness in.	R h·ft ² ·°F/Btu	U Btu/ (h·ft ² ·°F)	k Btu/ (h·ft·°F)	DENSITY lb/ft ³	Cp Btu/(lb·°F)
CEILING/ATTIC AIR (1539 ft ² total area)						
Int Surf Coef		0.765	1.307			
Plasterboard	0.5	0.450	2.222	0.0926	50.0	0.26
Fiberglass batt (Note 1)	6.25	19.000	0.053	0.0274	0.6	0.20
Joists 2x6, 24" O.C. (Note 2)	5.5	6.872	0.146	0.0667	32.0	0.33
Attic air space (Note 3)		1.550	0.645			
ROOF DECK AND GABLE PROPERTIES SCALED TO CEILING AREA, 1539 ft ² (Note 4)						
Plywood 1/2"	0.5	0.515	1.940	0.0808	41.2	0.29
Hybrid shingle/siding (Note 5)	0.25	0.384	2.605	0.0543	84.8	0.30
Total roof deck/gable, surf-surf (Note 6)		0.899	1.112			
Ext Surf Coef (Note 7)		0.144	6.967			
SUMMARY CEILING/ATTIC/ROOF						
Total air-air, insulated section		22.808	0.044			
Total air-air, framed section		10.679	0.094			
Total composite, air-air (Note 8)		20.482	0.049			
Total composite, surf-surf (Note 9)		19.573	0.051			

Note 1: Insulated section only, see Figure 7-6 for section view of ceiling/attic/roof.

Note 2: Framed section only, see Figure 7-6 for section view of ceiling/attic/roof.

Note 3: Average winter/summer values for natural ventilation (2.4 ach), R-19 ceiling insulation, ext abs = 0.6, includes interior films.

Note 4: Scaled properties are presented for use with ASHRAE equivalent attic air space R-value. U, R and k are scaled on area, while density and specific heat are scaled on volume (area and thickness).

Note 5: This "material" combines roofing and end gable materials into one hybrid layer of material.

Note 6: Based on total roof/gable UA, surf-surf calculated in Table 7-6.

Note 7: Scaled to 1539 ft²

Note 8: (ceiling interior film coefficient) + (ceiling materials) + (attic as material layer) + (scaled roof deck/gable materials) + (scaled exterior film coefficient). Based on 90% insulated section and 10% frame section per ASHRAE.

Note 9: Based on total air-air R-value less R-values of interior film coefficient and scaled exterior film coefficient.

TABLE 7-8 Material Descriptions, Interior Wall—Case L100A

INTERIOR WALL						
ELEMENT (Source)	Thickness in.	R h·ft ² ·°F/Btu	U Btu/(h·ft ² ·°F)	k Btu/(h·ft·°F)	DENSITY lb/ft ³	Cp Btu/(lb·°F)
Int Surf Coef		0.685	1.460			
Plasterboard	0.50	0.450	2.222	0.0926	50.0	0.26
Frame 2x4, 16" O.C. (Note 1)	3.50	4.373	0.229	0.0667	32.0	0.33
Plasterboard	0.50	0.450	2.222	0.0926	50.0	0.26
Int Surf Coef		0.685	1.460			

Note 1: Frame 2x4 only applies to 10% of the interior wall area. Remaining area is air space that is disregarded.

TABLE 7-9 Internal Loads Schedule—Case L100A

Hour of Day (Note 1)	Sensible Load (Btu) (Note 2)	Latent Load (Btu) (Note 2)	Hour of Day	Sensible Load (Btu)	Latent Load (Btu)
1	1139	247	13	1707	370
2	1139	247	14	1424	308
3	1139	247	15	1480	321
4	1139	247	16	1480	321
5	1139	247	17	2164	469
6	1903	412	18	2334	506
7	2391	518	19	2505	543
8	4782	1036	20	3928	851
9	2790	604	21	3928	851
10	1707	370	22	4101	888
11	1707	370	23	4101	888
12	2277	493	24	3701	802
			Totals	56105	12156

Note 1: Hour 1 = the interval from midnight to 1am.

Note 2: Includes all possible sources of internal gains; sensible loads are 70% radiative and 30% convective.

TABLE 7-10 Window Summary, Single Pane Aluminum Frame with Thermal Breaks—Case L100A

Property	Value	Units	Notes
GENERAL PROPERTIES			
Area, gross window	15.00	ft ²	(Note 1)
Width, frame	2.75	in.	
Area, frame	4.04	ft ²	
Area, edge of glass (EOG)	3.57	ft ²	
Area, center of glass (COG)	7.39	ft ²	
Area, net glass	10.96	ft ²	(Area,EOG + Area,COG)
OPTICAL PROPERTIES			
Absorptance, frame	0.60		
Transmittance, frame	0.00		
COG/EOG optical properties	(see Table 7-11)		(Note 2)
Solar Heat Gain Coefficient (SHGC), gross window	0.670		(Note 3)
Shading Coefficient (SC), gross window	0.781		(Note 3)
Dividers, curtains, blinds, and other obstructions in window	None		
THERMAL PROPERTIES (conductances/resistances include film coefficients)			
Conductance, frame (R-Value)	0.971 1.030	Btu/(h·ft ² ·°F) h·ft ² ·°F/Btu	Aluminum frame with thermal break (Note 4)
Conductance, edge of glass (R-Value)	1.064 0.940	Btu/(h·ft ² ·°F) h·ft ² ·°F/Btu	
Conductance, center of glass (R-Value)	1.064 0.940	Btu/(h·ft ² ·°F) h·ft ² ·°F/Btu	
Conductance, net glass (R-Value)	1.064 0.940	Btu/(h·ft ² ·°F) h·ft ² ·°F/Btu	(Note 5)
Conductance, gross window (R-Value)	1.039 0.963	Btu/(h·ft ² ·°F) h·ft ² ·°F/Btu	(Note 6)
COMBINED SURFACE COEFFICIENT CONDUCTANCES			
Exterior Surf Coef, glass and frame	4.256	Btu/(h·ft ² ·°F)	based on output of WINDOW 4.1
Interior Surface Coefficient, glass	1.460	Btu/(h·ft ² ·°F)	based on output of WINDOW 4.1
Interior Surface Coefficient, frame	1.460	Btu/(h·ft ² ·°F)	from ASHRAE (Note 7)

Note 1: Area for one representative window unit. See Fig. 7-8 for a schematic representation of frame, center-of-glass (COG) and edge-of-glass (EOG) areas; dimensions are based on an NFRC size AA vertical slider. Gross window area is the sum of frame, COG and EOG areas.

Note 2: Edge-of-glass optical properties are the same as the center-of-glass properties. Table 7-12 gives optical properties as a function of incidence angle.

Note 3: These are the overall window (including COG, EOG, and frame) properties for direct normal solar radiation.

Note 4: The frame conductance presented here is based on the ASHRAE value for operable 1-pane window with aluminum frame with thermal break adjusted for the exterior surface coefficients also shown in this table. Material properties for dynamic modeling of window frames (density, specific heat, etc.) are not given.

Note 5: Net glass conductance includes only the COG and EOG portions of the window.

Note 6: Gross window conductance includes the frame, EOG, and COG portions of the window.

Note 7: See Informative Annex B5, Section B5.3.

TABLE 7-11 Glazing Summary, Single Pane Center of Glass Values—Case L100A

Property	Value	Units
GENERAL PROPERTIES		
Number of Panes	1	
Pane Thickness	0.118	in.
SINGLE PANE OPTICAL PROPERTIES (Note 1)		
Transmittance	0.837	
Reflectance	0.075	
Absorptance	0.088	
Index of Refraction	1.5223	
Extinction Coefficient	0.7806	/in.
Solar Heat Gain Coefficient (SHGC)	0.857	
Shading Coefficient (SC)	1.000	
Optical Properties as a Function of Incident Angle	(See Table 7-12)	
THERMAL PROPERTIES		
Conductivity of Glass	0.520	Btu/(h·ft·°F)
Conductance of Glass Pane (R-Value)	52.881 0.019	Btu/(h·ft ² ·°F) h·ft ² ·°F/Btu
Exterior Combined Surface Coefficient (R-Value)	4.256 0.235	Btu/(h·ft ² ·°F) h·ft ² ·°F/Btu
Interior Combined Surface Coefficient (R-Value)	1.460 0.685	Btu/(h·ft ² ·°F) h·ft ² ·°F/Btu
U-Value from Interior Air to Ambient Air (R-Value)	1.064 0.940	Btu/(h·ft ² ·°F) h·ft ² ·°F/Btu
Hemispherical Infrared Emittance	0.84	
Infrared Transmittance	0	
Density of Glass	154	lb/ft ³
Specific Heat of Glass	0.18	Btu/(lb·°F)

Note 1: Optical properties listed in this table are for direct normal radiation.

TABLE 7-12 Optical Properties as a Function of Incidence Angle for Single Pane Glazing—Case L100A

Angle	Properties (Notes 1, 2)			
	Trans	Refl	Abs	SHGC
0	0.837	0.075	0.088	0.857
10	0.836	0.075	0.089	0.857
20	0.835	0.075	0.090	0.856
30	0.830	0.077	0.093	0.852
40	0.821	0.083	0.097	0.843
50	0.800	0.099	0.101	0.823
60	0.752	0.143	0.105	0.776
70	0.639	0.253	0.108	0.664
80	0.390	0.505	0.105	0.414
90	0.000	1.000	0.000	0.000
Hemis	0.756	0.136	0.098	0.779

Note 1: Trans = Transmittance, Refl = Reflectance, Abs = Absorptance, SHGC = Solar Heat Gain Coefficient, Hemis = Hemispherically integrated property.

Note 2: Output is from WINDOW 4.1 for the following properties at direct normal incidence: transmittance = 0.837, reflectance = 0.075. SHGC accounts for surface coefficients, and is based on wind speed = 10.7 mph.

7.2.2 The Tier 1 Test Cases. This section describes revisions to the base building required to model the other Tier 1 cases. In some instances the base building for a case is not Case L100A. Cases for which L100A is not the basis are:

Case	Basis for that Case
L155A	L150A
L202A	L200A
L304A	L302A
L324A	L322A

For convenience, relevant portions of the appropriate base building tables and figures have been reprinted, with changes highlighted in bold font. Where applicable, summary figures and tables are listed first, with supplementary tables listed afterward.

7.2.2.1 Case L110A: High Infiltration (1.5 ACH). Case L110A is **exactly as Case L100A**, **except** that infiltration for the conditioned zone is changed as shown in Table 7-13. Attic infiltration rate remains unchanged.

TABLE 7-13 Conditioned Zone Infiltration for Case L110A

Infiltration Algorithm	ACH	CFM
w/ automatic altitude adjustment	1.5	307.8
w/ site fixed at sea level		
Colorado Springs, CO	1.194	244.9
Las Vegas, NV	1.383	283.9

The Colorad.TMY and Lasvega.TMY climate sites are at 6145 ft and 2178 ft altitude, respectively, so the density of air is less than that at sea-level for both locations. If the program being tested does not use barometric pressure from the weather data, or otherwise does not automatically corrects for

the change in air density caused by altitude, then adjust the specified infiltration rates (to yield mass flows equivalent to what would occur at the specified altitude) as shown in Table 7-13. The listed infiltration rate is independent of wind speed, indoor/outdoor temperature difference, etc. The calculation technique used for developing altitude effects on infiltration is included in informative Annex B3.

7.2.2.2 Case L120A: Well-Insulated Walls and Roof. Case L120A is **exactly as Case L100A**, **except** that an extra layer of R-38 batt insulation has been added to the ceiling, and exterior walls have 2x6 24" O.C. framing and R-18 batt insulation with R-7.2 polyisocyanurate exterior board insulation. The following figures and table highlight information that is expected to be useful to most users.

- Figure 7-9 Exterior Wall Plan Section - Case L120A
- Figure 7-10 Ceiling Section - Case L120A
- Table 7-14 Building Thermal Summary - Case L120A.

Relevant supplementary tables that include more detailed information are:

- Table 7-15 Component Surface Areas and Solar Fractions - Case L120A
- Table 7-16 Material Descriptions, Exterior Wall - Case L120A
- Table 7-17 Material Descriptions, Ceiling - Case L120A
- Table 7-18 Material Descriptions for Attic as Material Layer - Case L120A (for calculation of equivalent ceiling/attic/roof composite R-value, see discussion of the base building attic in Section 7.2.1.4).

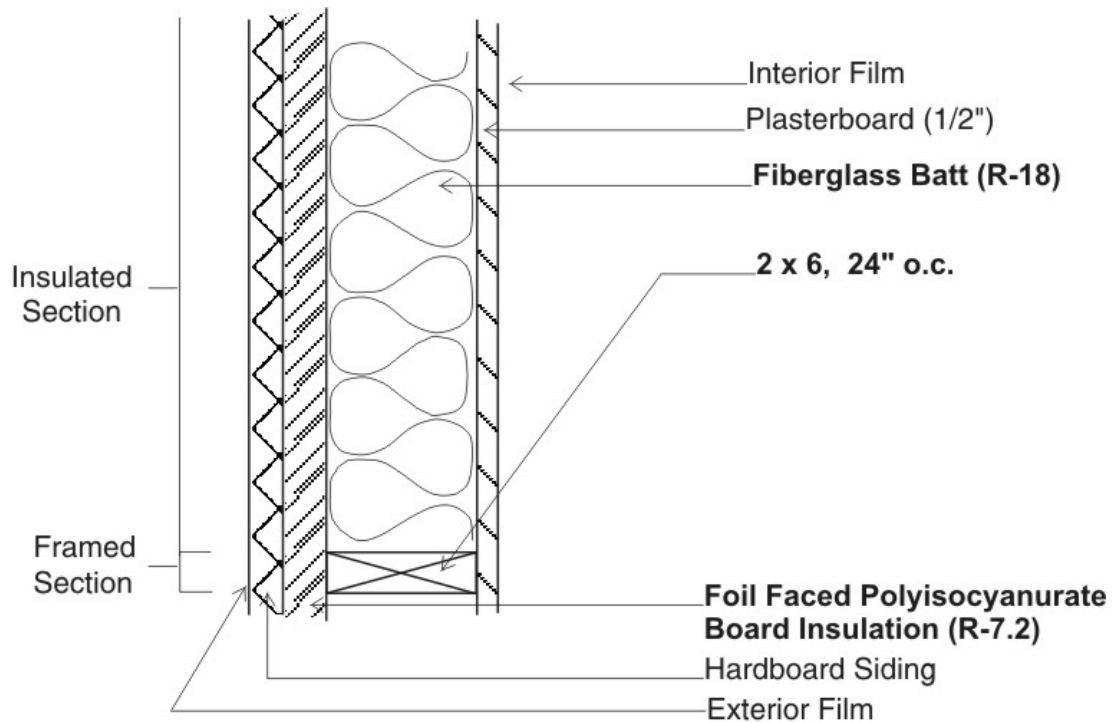

CD-RH06-A0327320A

Note: Changes to Case L100A are highlighted with bold font.

Figure 7-9 Exterior wall plan section—Case L120A.

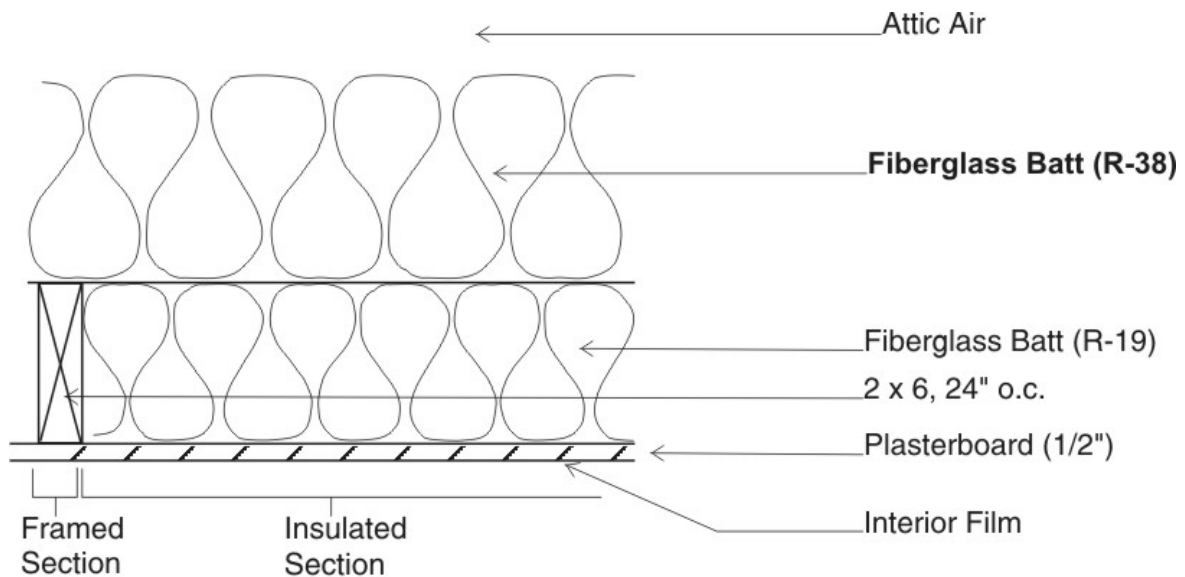

CD-RH06-A0327320B

Note: Changes to Case L100A are highlighted with bold font.

Figure 7-10 Ceiling section—Case L120A.

TABLE 7-14 Building Thermal Summary—Case L120A

ELEMENT	Area ft ²	R h·ft ² ·°F/Btu	U Btu/(h·ft ² ·°F)	UA Btu/(h·°F)	HEATCAP Btu/°F
(Note 1)		(Note 2)	(Note 2)	(Note 2)	(Note 3)
Exterior Walls (Note 4)	1034	23.58	0.042	43.8	1749
North Windows	90	0.96	1.039	93.5	
East Windows	45	0.96	1.039	46.7	
West Windows	45	0.96	1.039	46.7	
South Windows	90	0.96	1.039	93.5	
Doors	40	3.04	0.329	13.2	62
Ceiling/Attic/Roof (Note 5)	1539	59.53	0.017	25.9	1850
Floor (Note 5)	1539	14.15	0.071	108.8	1471
Infiltration					
Colorado Springs, CO				118.2	
Las Vegas, NV				136.9	
Interior Walls	1024				1425
TOTAL BUILDING					6556
Excluding Infiltration				472.1	
Including Infiltration (Colorado Springs, CO)				590.3	
Including Infiltration (Las Vegas, NV)				609.1	

Note 1: Changes to Case L100A are highlighted by bold font.

Note 2: Includes interior and exterior surface coefficients.

Note 3: Heat capacity includes building mass within the thermal envelope (e.g., insulation and insulation thickness of structural framing are included, exterior siding and roof/attic mass are excluded).

Note 4: Excludes window and door area. ASHRAE framed area fraction of 0.22 used for 2x6 24" O.C. construction.

Note 5: ASHRAE roof/ceiling framing area fraction of 0.1 used for both ceiling and floor.

TABLE 7-15 Component Surface Areas and Solar Fractions—Case L120A

ELEMENT	AREA	INSIDE SOLAR FRACTION
(Note 1)	ft ²	(Note 2)
EXTERIOR NORTH/SOUTH WALLS		(Note 2)
Net Wall (Note 3)	346.0	
Insulated Wall (Note 4)	269.9	0.0345
Framed Wall (Note 4)	76.1	0.0097
EXTERIOR EAST/WEST WALLS		
Net Wall (Note 3)	171.0	
Insulated Wall (Note 4)	133.4	0.0171
Framed Wall (Note 4)	37.6	0.0048

Note 1. Changes to Case L100A are highlighted by bold font. All other surface areas remain as in Case L100A.

Note 2. Solar energy transmitted through windows is assumed as distributed to interior opaque surfaces in proportion to their areas. Only the radiation not directly absorbed by light-weight furnishings (assumed to exist only for the purpose of calculating inside solar fraction) or lost back out through windows is distributed to interior opaque surfaces.

Note 3. Net wall area is the gross wall area less the rough opening areas of the windows and door.

Note 4. Insulated and framed exterior wall sections are defined in Figure 7-9. ASHRAE framed area fraction of 0.22 is assumed for 2x6 24" O.C. construction.

TABLE 7-16 Material Descriptions, Exterior Wall—Case L120A

EXTERIOR WALL (inside to outside)	(Note 1)					
	Thickness	R	U	k	DENSITY	Cp
ELEMENT (Source)	in.	$\text{h}\cdot\text{ft}^2\cdot\text{°F}/\text{Btu}$	$\text{Btu}/(\text{h}\cdot\text{ft}^2\cdot\text{°F})$	$\text{Btu}/(\text{h}\cdot\text{ft}\cdot\text{°F})$	lb/ft^3	$\text{Btu}/(\text{lb}\cdot\text{°F})$
Int Surf Coef		0.685	1.460			
Plasterboard	0.5	0.450	2.222	0.0926	50.0	0.26
Fiberglass batt (Note 2)	5.5	18.000	0.056	0.0255	0.68	0.20
Frame 2x6 24" O.C. (Note 3)	5.5	6.872	0.146	0.0667	32.0	0.33
Isocyanurate board insulation	1.0	7.200	0.139	0.0116	2.0	0.22
Hardboard siding, 7/16"	0.44	0.670	1.492	0.0544	40.0	0.28
Ext Surf Coef		0.174	5.748			
Total air - air, insulated section		27.179	0.037			
Total air - air, frame section		16.051	0.062			
Total air - air, composite section (Note 4)		23.582	0.042			
Total surf - surf, insulated section		26.320	0.038			
Total surf - surf, frame section		15.192	0.066			
Total surf - surf, composite section (Note 5)		22.723	0.044			

Note 1: Changes to Case L100A are highlighted in bold font.

Note 2: Insulated section only, see Figure 7-9 for wall section view. Properties adjusted for compression of batt into cavity.

Note 3: Framed section only, see Figure 7-9 for section view of wall.

Note 4: Total composite R-values from 78% insulated section, 22% framed section per ASHRAE. Thermal properties of windows and doors are not included in this composite calculation.

Note 5: Total surf-surf composite R-value is the total air-air composite R-value less the resistances due to the film coefficients.

TABLE 7-17 Material Descriptions, Ceiling—Case L120A

CEILING (inside to outside) (Note 1)						
ELEMENT	Thickness in.	R h·ft ² ·°F/Btu	U Btu/(h·ft ² ·°F)	k Btu/(h·ft·°F)	DENSITY lb/ft ³	Cp Btu/(lb·°F)
CEILING (1539 ft ² total area)						
Int Surf Coef		0.765	1.307			
Plasterboard	0.5	0.450	2.222	0.0926	50.0	0.26
Fiberglass batt (Note 2)	6.25	19.000	0.053	0.0274	0.6	0.20
Joists 2x6 24" O.C. (Note 3)	5.5	6.872	0.146	0.0667	32.0	0.33
Fiberglass batt	12.0	38.000	0.026	0.0263	0.6	0.20
Int Surf Coef		0.765	1.307			
Total air-air, insulated section		58.980	0.017			
Total air-air, framed section		46.852	0.021			
Total air-air, composite section	(Note 4)	57.492	0.017			
Total surf-surf, composite sec.	(Note 4)	55.962	0.018			

Note 1: Changes to Case L100A are highlighted with bold font. Use this table if attic modeled as separate zone.

Note 2: Insulated section only, see Figure 7-10 for section view of ceiling.

Note 3: Framed section only, see Figure 7-10 for section view of ceiling.

Note 4: Based on 90% insulated section and 10% frame section per ASHRAE; applies to temperature difference between room air and attic air. The "Composite surf-surf" R-value is the composite air-air R-value less the two interior film coefficient R-values.

TABLE 7-18 Material Descriptions for Attic as Material Layer—Case L120A

COMPOSITE CEILING/ATTIC/ROOF (inside to outside)						
(Note 1)	Thickness	R	U	k	DENSITY	Cp
ELEMENT	in.	h·ft ² ·°F/Btu	Btu/(h·ft ² ·°F)	Btu/(h·ft ² ·°F)	lb/ft ³	Btu/(lb·°F)
CEILING/ATTIC (1539 ft ² total area)						
Int Surf Coef		0.765	1.307			
Plasterboard	0.5	0.450	2.222	0.0926	50.0	0.26
Fiberglass batt (Note 2)	6.25	19.000	0.053	0.0274	0.6	0.20
Joists 2x6 24" O.C. (Note 3)	5.5	6.872	0.146	0.0667	32.0	0.33
Fiberglass batt	12.0	38.000	0.026	0.0263	0.6	0.20
Attic air space (Note 4)		1.750	0.571			
Total roof deck/gable, surf-surf (Note 5)		0.899	1.112			
Ext Surf Coef (Note 6)		0.144	6.967			
SUMMARY CEILING/ATTIC/ROOF						
Total air-air, insulated section		61.008	0.016			
Total air-air, framed section		48.879	0.020			
Total air-air, composite section (Note 7)		59.531	0.017			
Total surf-surf, composite sec. (Note 8)		58.622	0.017			

Note 1: Changes to Case L100A are highlighted by bold font. Use this table if attic modeled as material layer.

Note 2. Insulated section only, see Figure 7-10 for section view of ceiling.

Note 3. Insulated section only, see Figure 7-10 for section view of ceiling.

Note 4. Average winter/summer values for natural vent (2.4 ach), R-30 ceiling insulation, ext abs = 0.6, includes interior films.

Note 5. From Table 7-7 (Case L100A).

Note 6. Scaled to 1539 ft².

Note 7. Based on 10% frame area fraction per ASHRAE; applies to temperature difference between room air and ambient air.

Note 8. Based on total air-air R-value less R-values of interior film coefficient and scaled exterior film coefficient.

7.2.2.3 Case L130A: Double-Pane Low-Emissivity Window with Wood Frame. Case L130A is exactly as Case L100A, except that all single-pane windows are replaced with double-pane low-emissivity (low-e) windows with wood frames and insulated spacers. The basic properties of the window, including shading coefficient, solar heat gain coefficient and thermal resistance, are provided in:

- Table 7-19 Building Thermal Summary - Case L130A. Window and frame geometry remain as for Case L100A.

Relevant supplementary tables that include more detailed information are:

- Table 7-20 Window Summary (Double-Pane, Low-E, Argon Fill, Wood Frame, Insulated Spacer) -Case L130A
- Table 7-21 Glazing Summary, Low-E Glazing System with Argon Gas Fill (Center of Glass Values) - Case L130A
- Table 7-22 Optical Properties as a Function of Incidence Angle for Low-Emissivity Double-Pane Glazing - Case L130A

- Table 7-23 Component Solar Fractions - Case L130A.

Use only the information that is relevant to the program being tested. Window properties are drawn from the WINDOW 4.1^{B-6} software for window thermal analysis. For programs that need transmittance or reflectance at other angles of incidence, interpolate between the values of Table 7-22 using the cosine of the incidence angle as the basis of interpolation. Where other unspecified data are needed, then values that are consistent with those quoted must be calculated.

There is a slight change in interior surface solar distribution caused by reduced solar lost (cavity albedo); for those tools that can vary this input, values are included in Table 7-23.

Because of the large number of changes to the glazing for this case, Tables 7-20 through 7-22 have **not** been highlighted with bold font to show where changes occurred.

TABLE 7-19 Building Thermal Summary—Case L130A

ELEMENT	Area ft ²	R h·ft ² ·°F/Btu (Note 2)	U Btu/(h·ft ² ·°F) (Note 2)	UA Btu/(h·°F) (Note 2)	HEATCAP Btu/°F (Note 3)
Exterior Walls (Note 4)	1034	11.76	0.085	87.9	1383
North Windows (Note 5)	90	3.33	0.300	27.0	
East Windows (Note 5)	45	3.33	0.300	13.5	
West Windows (Note 5)	45	3.33	0.300	13.5	
South Windows (Note 5)	90	3.33	0.300	27.0	
Doors	40	3.04	0.329	13.2	62
Ceiling/Attic/Roof (Note 6)	1539	20.48	0.049	75.1	1665
Floor (Note 6)	1539	14.15	0.071	108.8	1471
Infiltration					
Colorado Springs, CO				118.2	
Las Vegas, NV				136.9	
Interior Walls	1024				1425
TOTAL BUILDING					6006
Excluding Infiltration				366.1	
Including Infiltration (Colorado Springs, CO)				484.3	
Including Infiltration (Las Vegas, NV)				503.1	
WINDOW SUMMARY: DOUBLE-PANE, LOW-E, WOOD FRAME, INSULATED SPACER					
(Note 7)	Area ft ²	U Btu/(h·ft ² ·°F) (Note 2)	SHGC (dir. nor.) (Note 8)	Trans. (dir. nor.) (Note 9)	SC (Note 10)
Dbl-pane, low-e, argon	10.96	0.247	0.432	0.387	0.504
Wood frame, insulated spacer	4.04	0.446			
Window, composite	15.00	0.300	0.335	0.283	0.391

Note 1: Changes to Case L100A are highlighted by bold font.

Note 2: Includes interior and exterior surface coefficients.

Note 3: Heat capacity includes building mass within the thermal envelope (e.g., insulation and insulation thickness of structural framing are included, exterior siding and roof/attic mass are excluded).

Note 4: Excludes area of windows and doors. ASHRAE framed area fraction of 0.25 is assumed for 2x4 16" O.C. construction.

Note 5: Window area and other properties are for glass and frame combined. The accompanying window summary disaggregates glass and frame properties for a single window unit. North and south walls contain six window units each; east and west walls contain three window units each.

Note 6: ASHRAE roof/ceiling framing area fraction of 0.1 applied to both ceiling and floor.

Note 7: This data summarizes one complete detailed window unit per Figure 7-8 and Tables 7-20 through 7-22.

Note 8: SHGC is the Solar Heat Gain Coefficient, which includes the inward flowing fraction of absorbed direct normal solar radiation in addition to direct normal transmittance. For more detail, see ASHRAE 1993 Fundamentals, chapter 27 (Reference B-7).

Note 9: "Trans." is the direct normal transmittance.

Note 10: Shading coefficient (SC) is the ratio of direct normal SHGC for a specific glazing unit to direct normal SHGC for the WINDOW 4.1 reference glazing unit.

TABLE 7-20 Window Summary (Double-Pane, Low-E, Argon Fill, Wood Frame, Insulated Spacer)—Case L130A

Property	Value	Units	Notes
GENERAL PROPERTIES			
Area, gross window	15.00	ft ²	(Note 1)
Width, frame	2.75	in.	
Area, frame	4.04	ft ²	
Area, edge of glass (EOG)	3.57	ft ²	
Area, center of glass (COG)	7.39	ft ²	
Area, net glass	10.96	ft ²	(Area,EOG + Area,COG)
OPTICAL PROPERTIES			
Absorptance, frame	0.60		
Transmittance, frame	0.00		
COG/EOG optical properties	(see Table 7-21)		(Note 2)
Solar Heat Gain Coefficient (SHGC), gross window	0.335		(Note 3)
Shading Coefficient (SC), gross window	0.391		(Note 3)
Dividers, curtains, blinds, and other obstructions in window	None		
THERMAL PROPERTIES (conductances/resistances include film coefficients)			
Conductance, frame	0.446	Btu/(h·ft ² ·°F)	(Note 4)
(R-Value)	2.242	h·ft ² ·°F/Btu	
Conductance, edge of glass	0.265	Btu/(h·ft ² ·°F)	
(R-Value)	3.774	h·ft ² ·°F/Btu	
Conductance, center of glass	0.238	Btu/(h·ft ² ·°F)	
(R-Value)	4.202	h·ft ² ·°F/Btu	
Conductance, net glass	0.247	Btu/(h·ft ² ·°F)	(Note 5)
(R-Value)	4.052	h·ft ² ·°F/Btu	
Conductance, gross window	0.300	Btu/(h·ft ² ·°F)	(Note 6)
(R-Value)	3.329	h·ft ² ·°F/Btu	
COMBINED SURFACE COEFFICIENT CONDUCTANCES			
Exterior Surf Coef, glass and frame	4.256	Btu/(h·ft ² ·°F)	based on output of WINDOW 4.1
Interior Surface Coefficient, glass	1.333	Btu/(h·ft ² ·°F)	based on output of WINDOW 4.1
Interior Surface Coefficient, frame	1.460	Btu/(h·ft ² ·°F)	from ASHRAE (Note 7)

Note 1: Area for one representative window unit. See Fig. 7-8 for a schematic representation of frame, center-of-glass (COG) and edge-of-glass (EOG) areas; dimensions are based on an NFRC size AA vertical slider. Gross window area is the sum of frame, COG, and EOG areas.

Note 2: Edge-of-glass optical properties are the same as the center-of-glass optical properties. Table 7-22 gives optical properties as a function of incidence angle.

Note 3: These are overall window (including COG, EOG, and frame) properties for direct normal solar radiation.

Note 4: The frame conductance presented here is based on the ASHRAE value for operable two-pane window with wood/vinyl frame and insulated spacer adjusted for the exterior surface coefficients also shown in this table. Material properties for dynamic modeling of window frames (density, specific heat, etc.) are not given

Note 5: Net glass conductance includes only the COG and EOG portions of the window.

Note 6: Gross window conductance includes the frame, EOG, and COG portions of the window.

Note 7: See Informative Annex B5, Section B5.3.

**TABLE 7-21 Glazing Summary, Low-E Glazing System with Argon Gas Fill
(Center of Glass Values)—Case L130A**

Property	Value	Units
GENERAL PROPERTIES		
Number of Panes	2	
Pane Thickness	0.118	in.
Argon Gap Thickness	0.500	in.
OUTER PANE OPTICAL PROP.		
	(Note 1, Note 2)	
Transmittance	0.450	
Reflectance	0.340	
Absorptance	0.210	
Index of Refraction	(Note 3)	
Extinction Coefficient	(Note 3)	
INNER PANE OPTICAL PROP.		
Transmittance	0.837	
Reflectance	0.075	
Absorptance	0.088	
Index of Refraction	1.5223	
Extinction Coefficient	0.7806	/in.
DOUBLE PANE OPTICAL PROP.		
Transmittance	0.387	
Reflectance	0.356	
Absorptance (outer pane)	0.216	
Absorptance (inner pane)	0.041	
Solar Heat Gain Coefficient (SHGC)	0.432	
Shading Coefficient (SC)	0.504	
Optical Properties as a Function of Incident Angle	(See Table 7-22)	
THERMAL PROPERTIES		
Conductivity of Glass	0.520	Btu/(h·ft·°F)
Combined Radiative and Convective Coefficient of Argon Gap (R-Value)	0.316 3.170	Btu/(h·ft ² ·°F) h·ft ² ·°F/Btu
Conductance of Glass Pane (R-Value)	52.881 0.019	Btu/(h·ft ² ·°F) h·ft ² ·°F/Btu
Exterior Combined Surface Coef. (R-Value)	4.256 0.235	Btu/(h·ft ² ·°F) h·ft ² ·°F/Btu
Interior Combined Surface Coef. (R-Value)	1.333 0.750	Btu/(h·ft ² ·°F) h·ft ² ·°F/Btu
U-Value, Air-Air (R-Value)	0.238 4.202	Btu/(h·ft ² ·°F) h·ft ² ·°F/Btu
Hemispherical Infrared Emittance	0.84	(Note 2)
Infrared Transmittance	0	
Density of Glass	154	lb/ft ³
Specific Heat of Glass	0.18	Btu/(lb·°F)

Note 1: Optical properties listed in this table are for direct normal radiation.

Note 2: The inside facing surface of the outer pane has emissivity = 0.04.

Note 3: Single values of index of refraction and extinction coefficient do not adequately describe the optical properties of coated glass.

TABLE 7-22 Optical Properties as a Function of Incidence Angle for Low-Emissivity Double-Pane Glazing—Case L130A

Angle	Properties (Notes 1, 2)				
	Trans	Refl	Abs Out	Abs In	SHGC
0	0.387	0.356	0.216	0.041	0.432
10	0.390	0.350	0.219	0.041	0.434
20	0.384	0.349	0.226	0.041	0.429
30	0.376	0.351	0.231	0.042	0.422
40	0.366	0.359	0.232	0.043	0.413
50	0.347	0.374	0.236	0.044	0.394
60	0.305	0.402	0.250	0.043	0.353
70	0.226	0.472	0.264	0.038	0.271
80	0.107	0.640	0.224	0.029	0.142
90	0.000	0.999	0.001	0.000	0.000
Hemis	0.323	0.391	0.235	0.041	0.369

Note 1: Trans = Transmittance, Refl = Reflectance, Abs Out = Absorptance of outer pane, Abs In = Absorptance of inner pane, SHGC = Solar Heat Gain Coefficient, Hemis = Hemispherically integrated property. Transmittance, reflectance, and SHGC are overall properties for the glazing system (inside pane, argon fill, and outer pane) excluding the frame.

Note 2: Output is from WINDOW 4.1. SHGC accounts for surface coefficients, and is based on windspeed = 10.7 mph.

TABLE 7-23 Component Solar Fractions—Case L130A

ELEMENT (Note 1)	HEIGHT or		MULTIPLIER	AREA ft ²	INSIDE
	LENGTH ft	WIDTH ft			SOLAR FRACTION
EXTERIOR NORTH/SOUTH WALLS					(Note 2)
Gross Wall	8.0	57.0	1.0	456.0	
Gross Window	5.0	3.0	6.0	90.0	
Window Frame Only				24.2	0.0031
Door	6.67	3.0	1.0	20.0	0.0026
Net Wall (Note 3)				346.0	
Insulated Wall (Note 3)				259.5	0.0335
Framed Wall (Note 3)				86.5	0.0112
EXTERIOR EAST/WEST WALLS					
Gross Wall	8.0	27.0	1.0	216.0	
Gross Window	5.0	3.0	3.0	45.0	
Window Frame Only				12.1	0.0016
Net Wall (Note 3)				171.0	
Insulated Wall (Note 3)				128.3	0.0166
Framed Wall (Note 3)				42.8	0.0055
INTERIOR WALLS					
Gross Wall (Note 4)	8.0	128.0		1024.0	
Unframed Wall (Note 4)				921.6	0.1189
Framed Wall (Note 4)				102.4	0.0132
FLOOR/CEILING					
Gross Floor/Ceiling	57.0	27.0	1.0	1539.0	
Insulated Floor/Ceiling (Note 5)				1385.1	0.1788
Framed Floor/Ceiling (Note 5)				153.9	0.0199
TRANSMITTED SOLAR, INTERIOR DISTRIBUTION SUMMARY					
Total Opaque Interior Surface Area (Note 6)				6272.7	0.8096
Solar to Air (or low mass furnishings)					0.1750 (Note 7)
Solar Lost (back out through windows)					0.0154 (Note 8)

Note 1: Changes to Case L100A are highlighted with bold font.

Note 2: Solar energy transmitted through windows is assumed as distributed to interior opaque surfaces in proportion to their areas. Only the radiation not directly absorbed by light-weight furnishings (assumed to exist only for the purpose of calculating inside solar fraction) or not lost back out through windows is distributed to interior opaque surfaces.

Note 3: Net wall area is gross wall area less the rough opening areas of the windows and door. Insulated and framed exterior wall sections are defined in Figure 7-4. ASHRAE framed area fraction of 0.25 is assumed for 2x4 16" O.C. construction.

Note 4: Width is the total length of all interior walls. Framed wall area is assumed to be 10% of gross wall area for 2x4 16" O.C. framing. Only one side of the wall is considered for listed area. This area is multiplied by 2 for determining solar fractions. Solar fractions shown are for just one side of the interior wall.

Note 5: Insulated and framed floor and ceiling sections are defined in Figures 7-5 and 7-6 respectively. ASHRAE roof/ceiling framing area fraction of 0.1 applied to both ceiling and floor.

Note 6: Total area of just those surfaces to which an inside solar fraction is applied.

Note 7: Based on the midpoint of the range given by SUNCODE-PC User's Manual, p. 2-16.

Note 8: Calculated using the algorithm described in informative Annex B7, Section B7.2.

7.2.2.4 Case L140A: Zero Window Area. Case L140A is **exactly as Case L100A, except** the gross window area (glass and frame) is replaced with the Case L100A solid exterior wall materials of Figure 7-4 (see Case L100A); Table

7-4 (see Case L100A) is the corresponding supplementary table. The following tables summarize the changes:

- Table 7-24 Building Thermal Summary - Case L140A
- Table 7-25 Component Surface Areas - Case L140A.

TABLE 7-24 Building Thermal Summary—Case L140A

ELEMENT	AREA	R	U	UA	HEATCAP
(Note 1)	ft ²	h·ft ² ·°F/Btu	Btu/(h·ft ² ·°F)	Btu/(h·°F)	Btu/°F
Exterior Walls (Note 2)	1304	11.76	0.085	110.9	1745
North Windows	0	0.96	1.039	0.0	
East Windows	0	0.96	1.039	0.0	
West Windows	0	0.96	1.039	0.0	
South Windows	0	0.96	1.039	0.0	
Doors	40	3.04	0.329	13.2	62
Ceiling/Attic/Roof	1539	20.48	0.049	75.1	1665
Floor	1539	14.15	0.071	108.8	1471
Infiltration					
Colorado Springs, CO				118.2	
Las Vegas, NV				136.9	
Interior Walls	1024				1425
TOTAL BUILDING					6367
Excluding Infiltration				308.0	
Including Infiltration (Colorado Springs, CO)				426.1	
Including Infiltration (Las Vegas, NV)				444.9	

Note 1: Changes to Case L100A are highlighted by bold font. R- and U- values include surface coefficients.

Note 2: Excludes area of windows and doors. ASHRAE framed area fraction of 0.25 is assumed for 2x4 16" O.C. construction.

TABLE 7-25 Component Surface Areas—Case L140A

ELEMENT	HEIGHT	WIDTH	AREA
	ft	ft	ft ²
EXTERIOR NORTH/SOUTH WALLS			
Gross Wall	8.0	57.0	456.0
Door	6.67	3.0	20.0
Net Wall		(Note 1)	436.0
Insulated Wall		(Note 1)	327.0
Framed Wall		(Note 1)	109.0
EXTERIOR EAST/WEST WALLS			
Gross Wall	8.0	27.0	216.0
Insulated Wall		(Note 1)	162.0
Framed Wall		(Note 1)	54.0

Note 1: Net wall area is the gross wall area less the rough opening areas of the windows and door. Insulated and framed exterior wall sections are defined in Figure 7-4. ASHRAE framed area fraction of 0.25 is assumed for 2x4 16" O.C. construction.

7.2.2.5 Case L150A: South-Oriented Windows. This case is **exactly as Case L100A, except** that all windows have been moved to the South wall. These changes are summarized in the following:

- Figure 7-11 Exterior Wall and South Window Locations - Case L150A
- Figure 7-12 South Wall Elevation - Case L150A
- Table 7-26 Building Thermal Summary - Case L150A
- Table 7-27 Surface Component Areas and Solar Fractions - Case L150A.

7.2.2.5.1 Interior Solar Distribution. If the program being tested does not allow for variations of interior solar distribution, then this section may be disregarded. Interior solar distribution is the fraction of transmitted solar radiation incident on specific surfaces in a room. If the program being tested does not calculate this effect internally, then use the interior solar fractions from Table 7-27. The calculation of transmitted solar radiation reflected back out through windows (cavity albedo) is presented in informative Annex B7, Section B7.2.

Note: Interior walls are same as for Case L100A.

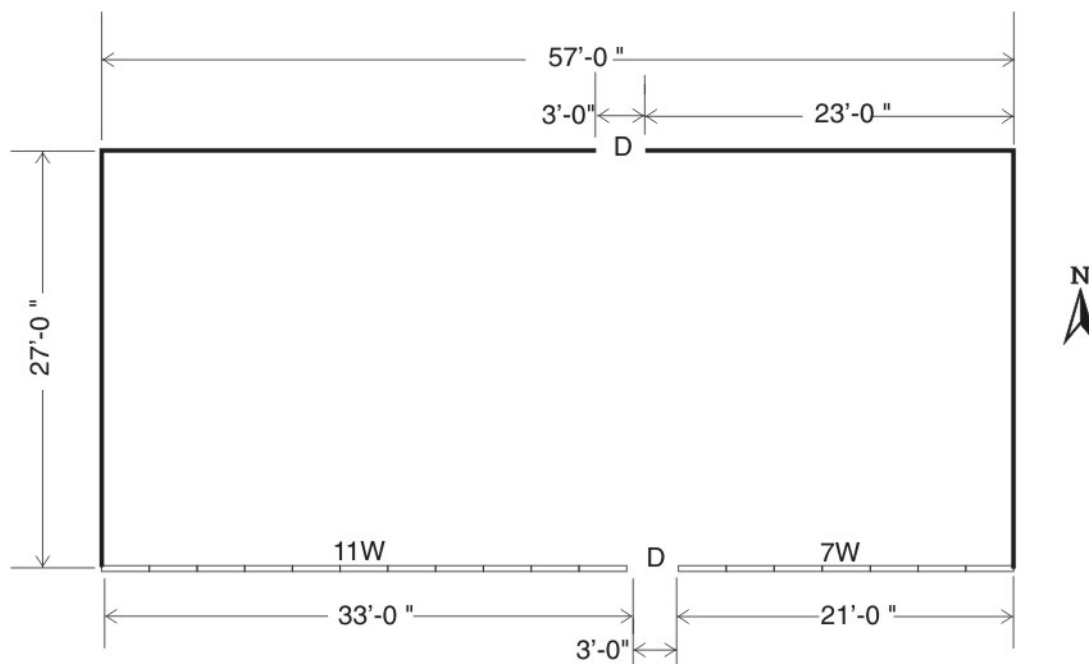

CD-RH06-A0327313

Legend:

#W:

W = Window (3' wide × 5' high), see Figure 7-8

= Number of windows along given length of exterior wall

D = Solid-core wood door (3' wide × 6'8" high)

Figure 7-11 Floor plan, exterior wall and south window locations—Case L150A.

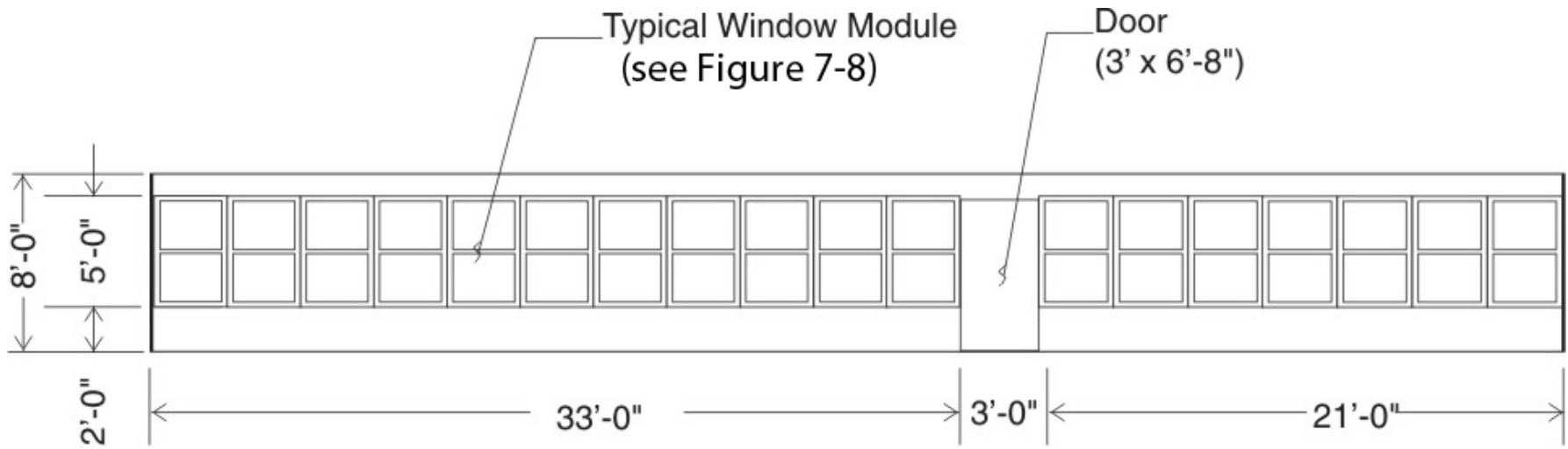

CD-RH06-A0327331B

Figure 7-12 South wall elevation—Case L 150A.

TABLE 7-26 Building Thermal Summary—Case L150A

ELEMENT	AREA	R	U	UA	HEATCAP
(Note 1)	ft ²	h·ft ² ·°F/Btu	Btu/(h·ft ² ·°F)	Btu/(h·°F)	Btu/°F
Exterior Walls (Note 2)	1034	11.76	0.085	87.9	1383
North Windows	0	0.96	1.039	0.0	
East Windows	0	0.96	1.039	0.0	
West Windows	0	0.96	1.039	0.0	
South Windows	270	0.96	1.039	280.5	
Doors	40	3.04	0.329	13.2	62
Ceiling/Attic/Roof	1539	20.48	0.049	75.1	1665
Floor	1539	14.15	0.071	108.8	1471
Infiltration					
Colorado Springs, CO				118.2	
Las Vegas, NV				136.9	
Interior Walls	1024				1425
TOTAL BUILDING					6006
Excluding Infiltration				565.5	
Including Infiltration (Colorado Springs, CO)				683.7	
Including Infiltration (Las Vegas, NV)				702.4	

Note 1: Changes to Case L100A are highlighted by bold font. R- and U- values include surface coefficients.

Note 2: Excludes area of windows and doors. ASHRAE framed area fraction of 0.25 is assumed for 2x4 16" O.C. construction.

TABLE 7-27 Surface Component Areas and Solar Fractions—Case L150A

ELEMENT (Note 1)	HEIGHT ft	WIDTH ft	MULTIPLIER	AREA ft ²	INSIDE
					SOLAR FRACTION
EXTERIOR SOUTH WALL					(Note 2)
Gross Wall	8.0	57.0	1.0	456.0	
Gross Window	5.0	3.0	18.0	270.0	
Window Frame Only				72.7	0.0093
Door	6.67	3.0	1.0	20.0	0.0026
Net Wall	(Note 3)			166.0	
Insulated Wall	(Note 3)			124.5	0.0159
Framed Wall	(Note 3)			41.5	0.0053
EXTERIOR NORTH WALL					
Gross Wall	8.0	57.0	1.0	456.0	
Door	6.67	3.0	1.0	20.0	0.0026
Net Wall	(Note 3)			436.0	
Insulated Wall	(Note 3)			327.0	0.0418
Framed Wall	(Note 3)			109.0	0.0139
EXTERIOR EAST/WEST WALLS					
Gross Wall	8.0	27.0	1.0	216.0	
Insulated Wall	(Note 3)			162.0	0.0207
Framed Wall	(Note 3)			54.0	0.0069

Note 1: Changes to Case L100A are highlighted with bold font. All windows have been moved to the south wall.

Note 2: Solar energy transmitted through windows is assumed as distributed to interior opaque surfaces in proportion to their areas. Only the radiation not directly absorbed by light-weight furnishings (assumed to exist only for the purpose of calculating inside solar fraction) or lost back out through windows is distributed to interior opaque surfaces.

Note 3: Net wall area is gross wall area less the rough opening areas of the windows and door. Insulated and framed exterior wall sections are defined in Figure 7-4. ASHRAE framed area fraction of 0.25 is assumed for 2x4 16" O.C. construction.

7.2.2.6 Case L155A: South-Oriented Windows with Overhang. Case L155A is **exactly as Case L150A, except** that an opaque overhang is included at the top of the south exterior wall. The overhang extends outward from this wall 2.5 ft, as shown in Figure 7-13. The overhang traverses the entire length of the south wall.

Depending on the input capabilities of the software being tested, it may not be possible to model the exact geometry of the windows and overhang as shown in Figure 7-13. If this is the case, a simplified model of the south wall may be used, such as the conceptual description shown in Figure 7-14. In Figure 7-14, glass and horizontally oriented framing directly

above and below the glass are aggregated into long units, with all elements located properly in the vertical direction to obtain the nearly equivalent shading of Figure 7-13. Proper dimensions for this example are obtained using Figure 7-8 (Case L100A), Figure 7-13 and Table 7-27 (Case L150A). The vertically oriented framing is similarly aggregated in a separate area so that equivalent shading will also result. While the overhang is not shown in Figure 7-14, it must be included as shown in Figure 7-13.

Note that, as explained in Section 7.1, this test requires use of consistent modeling methods for the test cases.

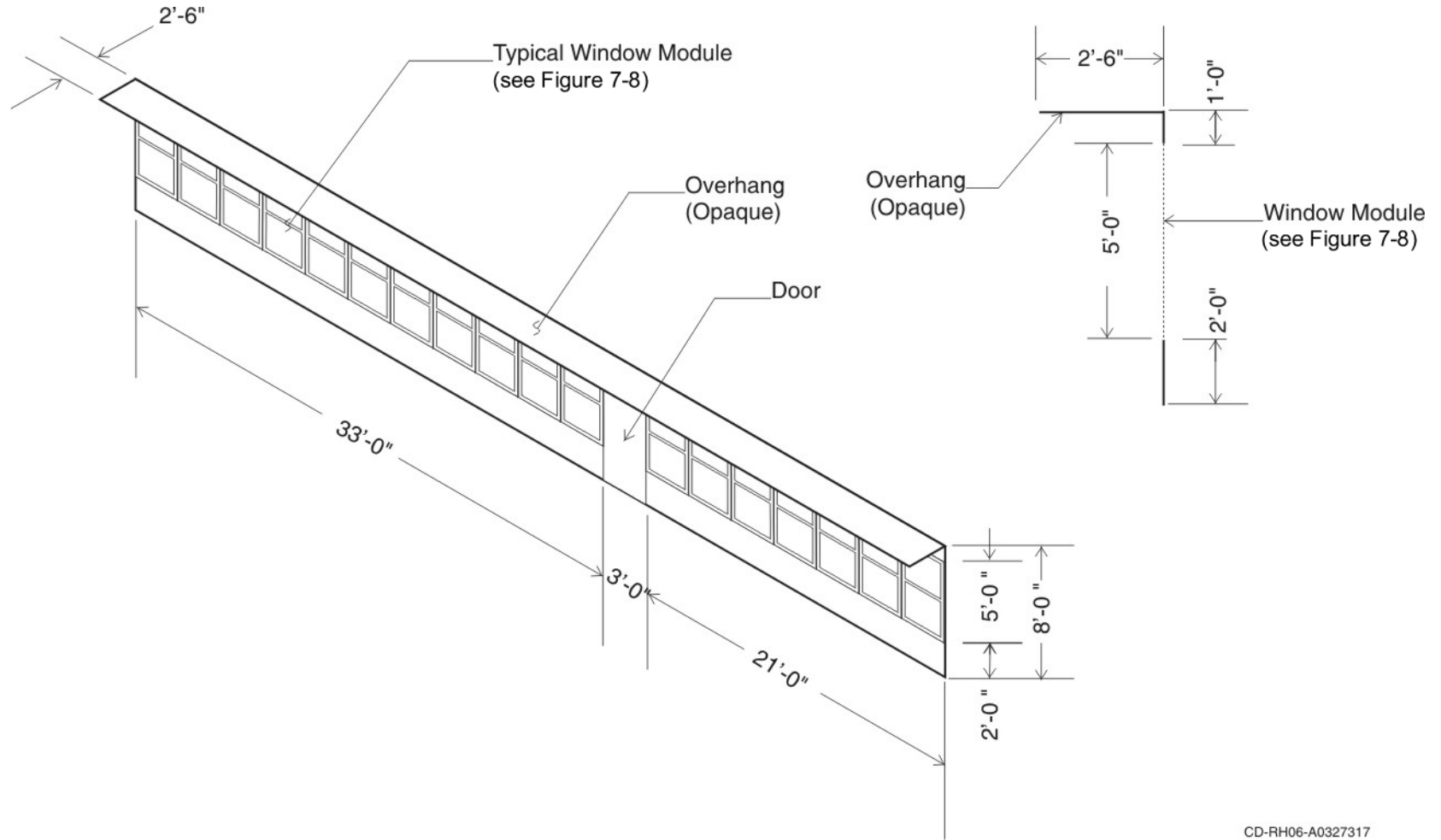

CD-RH06-A0327317

Figure 7-13 South overhang—Case L155A.

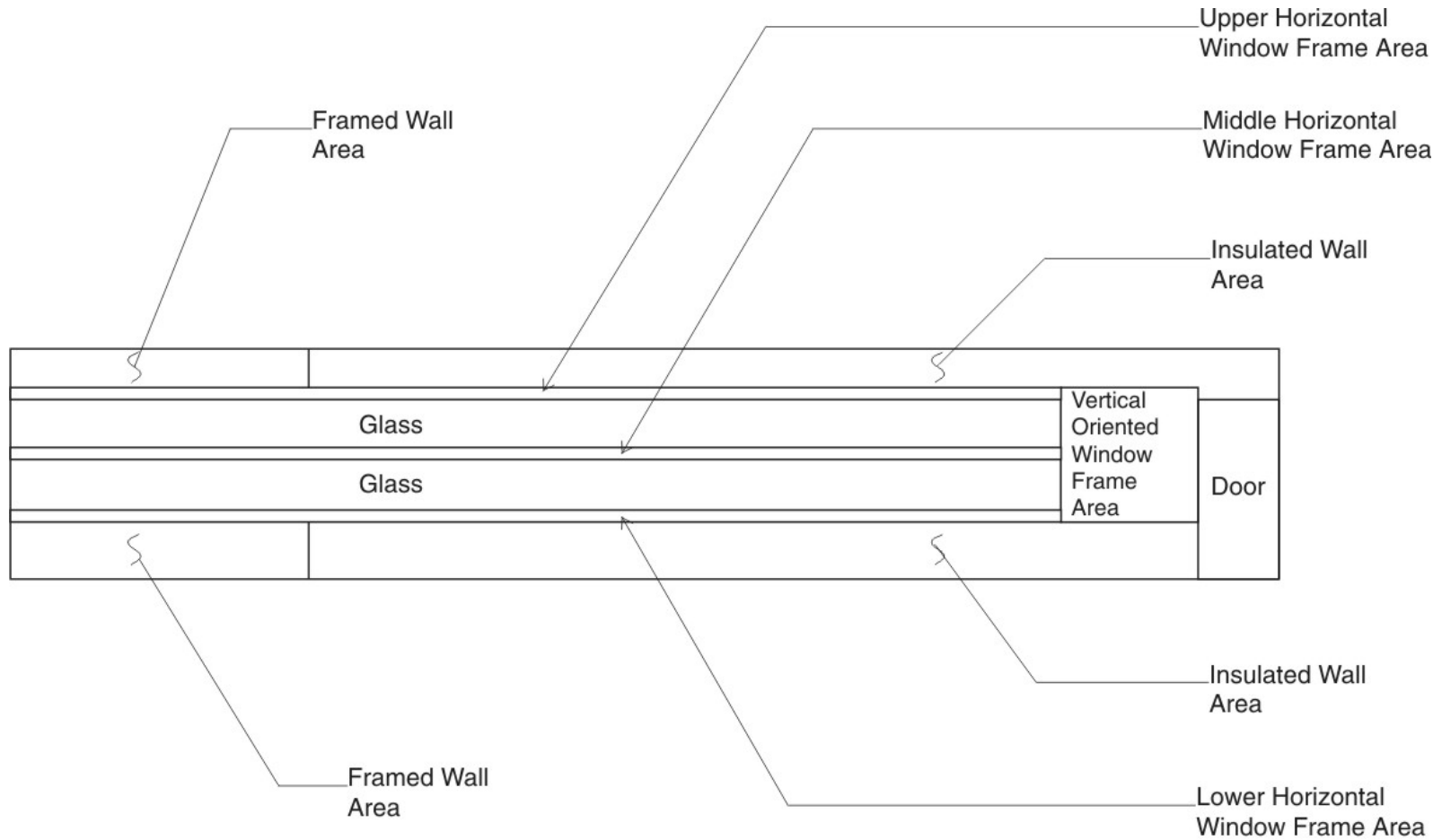

CD-RH06-A0327321

Figure 7-14 Example model of south wall for simulating south overhang effect in Case L155A.

7.2.2.7 Case L160A: East- and West-Oriented Windows. This case is **exactly as Case L100A, except** that all windows have been moved to the east and west walls. These changes are summarized in the following:

- Figure 7-15. East and West Window Locations, Plan - Case L160A
- Figure 7-16. East/West Wall Elevation - Case L160A
- Table 7-28. Building Thermal Summary - Case L160A
- Table 7-29. Surface Component Areas and Solar Fractions - Case L160A.

Note: Interior walls are the same as for Case L100A.

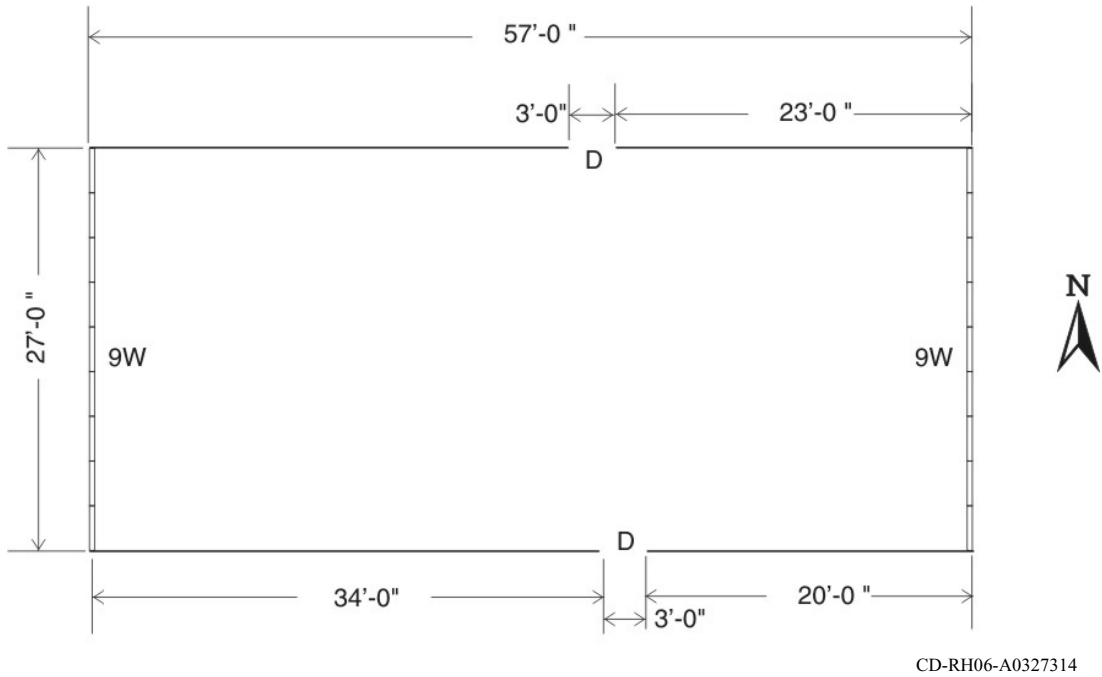

CD-RH06-A0327314

Legend:

#W:

W = window (3' wide × 5' high), see Figure 7-8

= number of windows along given length of exterior wall

D = solid-core wood door (3' wide × 6'8" high)

Figure 7-15 East and west window locations—Case L160A.

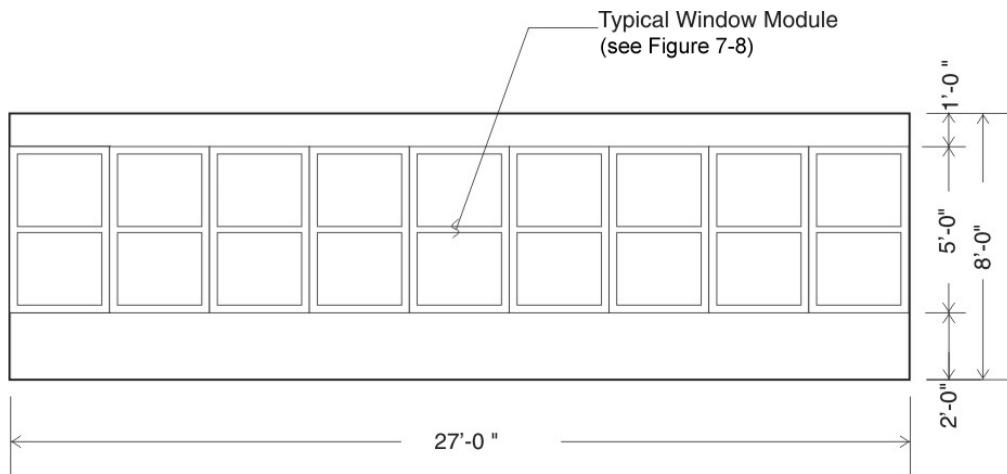

CD-RH06-A0327315

Figure 7-16 East/west wall elevation—Case L160A.

TABLE7-28 Building Thermal Summary—Case L160A

ELEMENT	AREA	R	U	UA	HEATCAP
(Note 1)	ft ²	h·ft ² ·°F/Btu	Btu/(h·ft ² ·°F)	Btu/(h·°F)	Btu/°F
Exterior Walls (Note 2)	1034	11.76	0.085	87.9	1383
North Windows	0	0.96	1.039	0.0	
East Windows	135	0.96	1.039	140.2	
West Windows	135	0.96	1.039	140.2	
South Windows	0	0.96	1.039	0.0	
Doors	40	3.04	0.329	13.2	62
Ceiling/Attic/Roof	1539	20.48	0.049	75.1	1665
Floor	1539	14.15	0.071	108.8	1471
Infiltration					
Colorado Springs, CO				118.2	
Las Vegas, NV				136.9	
Interior Walls	1024				1425
TOTAL BUILDING					6006
Excluding Infiltration				565.5	
Including Infiltration (Colorado Springs, CO)				683.7	
Including Infiltration (Las Vegas, NV)				702.4	

Note 1: Changes to Case L100A are highlighted by bold font. R- and U- values include surface coefficients.

Note 2: Excludes area of windows and doors. ASHRAE framed area fraction of 0.25 is assumed for 2x4 16" O.C. construction.

TABLE 7-29 Surface Component Areas and Solar Fractions—Case L160A

ELEMENT	HEIGHT	WIDTH	MULTIPLIER	AREA	INSIDE SOLAR FRACTION
(Note 1)	ft	ft		ft ²	
EXT. SOUTH/NORTH WALLS					(Note 2)
Gross Wall	8.0	57.0	1.0	456.0	
Door	6.67	3.0	1.0	20.0	0.0026
Net Wall	(Note 3)			436.0	
Insulated Wall	(Note 3)			327.0	0.0418
Framed Wall	(Note 3)			109.0	0.0139
EXT. EAST/WEST WALLS					
Gross Wall	8.0	27.0	1.0	216.0	
Gross Window	5.0	3.0	9.0	135.0	
Window Frame Only				36.4	0.0047
Net Wall	(Note 3)			81.0	
Insulated Wall	(Note 3)			60.8	0.0078
Framed Wall	(Note 3)			20.3	0.0026

Note 1: Changes to Case L100A are highlighted with bold font. All windows moved to the east and west walls.

Note 2: Solar energy transmitted through windows is assumed as distributed to interior opaque surfaces in proportion to their areas. Only the radiation not directly absorbed by light-weight furnishings (assumed to exist only for the purpose of calculating inside solar fraction) or not lost back out through windows is distributed to interior opaque surfaces

Note 3: Net wall area is gross wall area less the rough opening areas of the windows and door. Insulated and framed exterior wall sections are defined in Figure 7-4. ASHRAE framed area fraction of 0.25 is assumed for 2x4 16" O.C. construction.

7.2.2.8 Case L170A: No Internal Loads. Case L170A is **exactly as Case L100, except** the internal sensible and latent loads in the conditioned zone are set to zero for all hours of the entire year.

7.2.2.9 Case L200A: Energy Inefficient. This case is **exactly as Case L100A, except** for the following changes:

- Infiltration for the conditioned zone is 1.5 ach, as in Case L110A
- Exterior wall fiberglass insulation is replaced with an air gap
- Floor fiberglass insulation is eliminated
- Ceiling fiberglass insulation is reduced from 5.5" to 3.5"

The following figures and tables highlight information that is expected to be useful to most users.

- Figure 7-17 Exterior Wall Plan Section - Case L200A
- Figure 7-18 Raised Floor Exposed to Air, Section - Case L200A

- Figure 7-19 Ceiling Section - Case L200A
- Table 7-13 Conditioned Zone Infiltration for Case L110A (see Case L110A)
- Table 7-30 Building Thermal Summary - Case L200A.

Relevant supplementary tables that include more detailed information are:

- Table 7-31 Material Descriptions, Exterior Wall - Case L200A
- Table 7-32 Material Descriptions, Raised Floor Exposed to Air - Case L200A
- Table 7-33 Material Descriptions, Ceiling - Case L200A
- Table 7-34 Material Descriptions, Ceiling with Attic as Material Layer - Case L200A (for calculation of equivalent ceiling/attic/roof composite R-value, see discussion of the base building attic in Section 7.2.1.4).

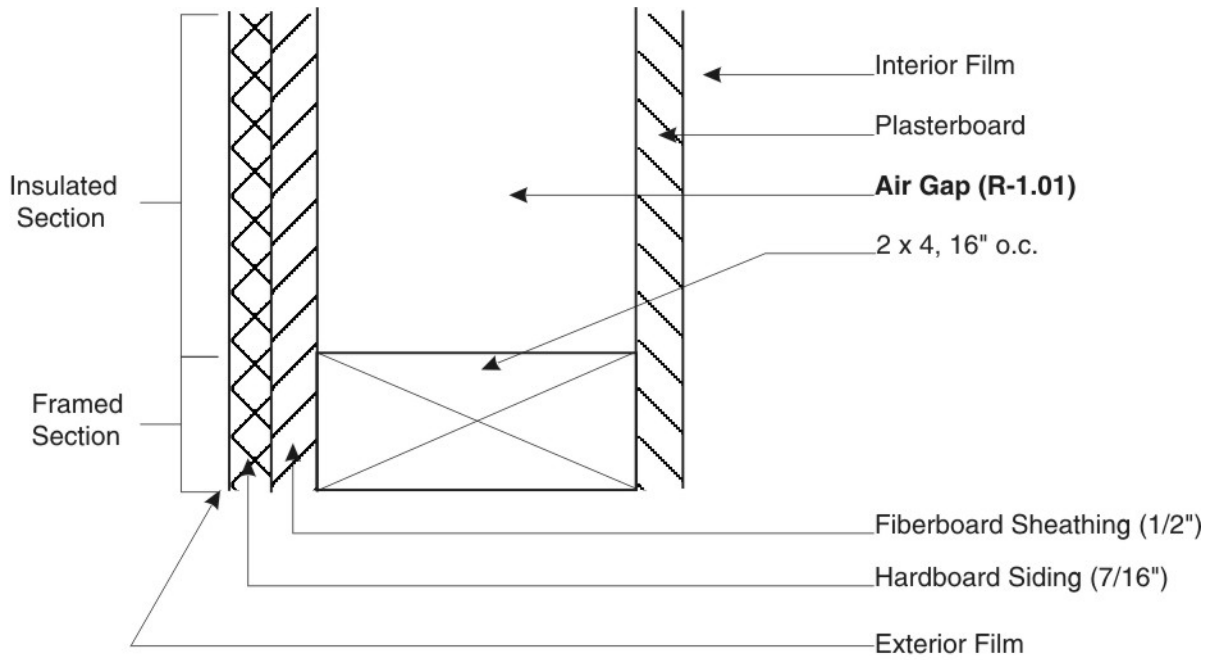

CD-RH06-A0327319A

Note: Changes to Case L100A are highlighted with bold font.

Figure 7-17 Exterior wall plan section—Case L200A.

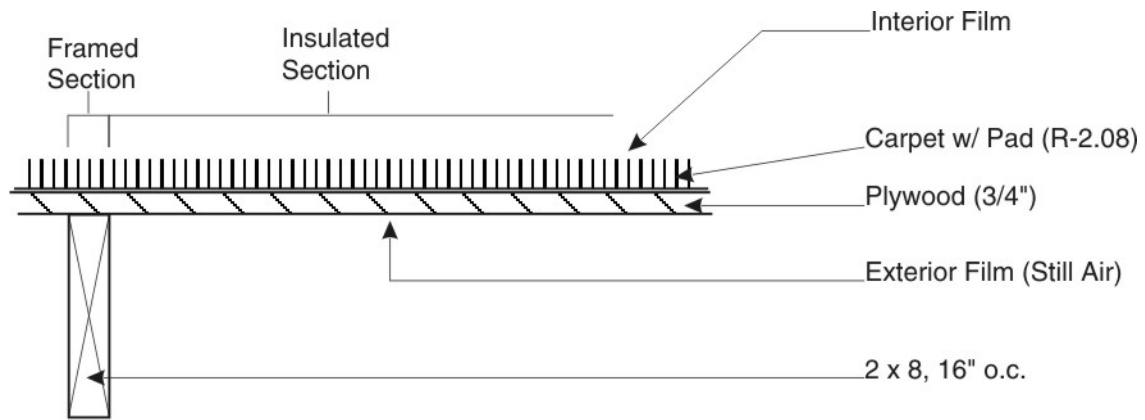

CD-RH06-A0327319B

Note: R-11 batt insulation of Case L100A has been removed.

Figure 7-18 Raised floor exposed to air, section—Case L200A.

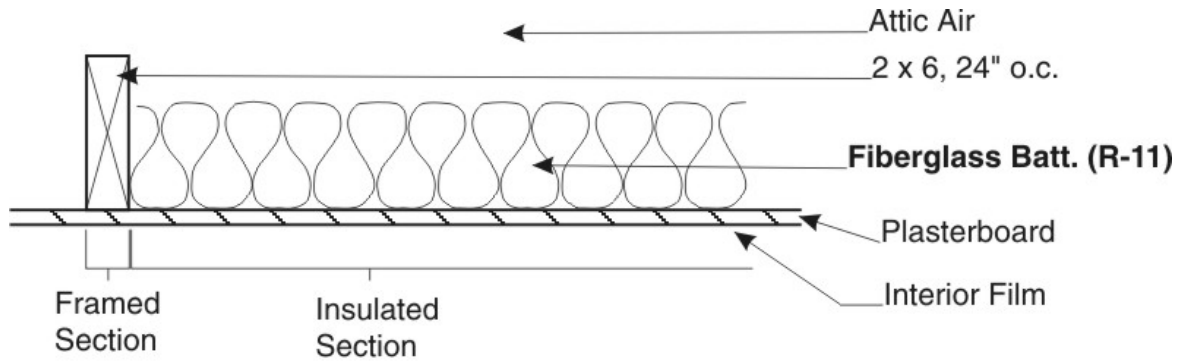

CD-RH06-A0327322

Note: Changes to Case L100A are highlighted with bold font.

Figure 7-19 Ceiling section—Case L200A.

TABLE 7-30 Building Thermal Summary—Case L200A

ELEMENT (Note 1)	AREA ft ²	R h·ft ² ·°F/Btu	U Btu/(h·ft ² ·°F)	UA Btu/(h·°F)	HEATCAP
					Btu/F (Note 2)
Exterior Walls (Note 3)	1034	4.84	0.207	213.7	1356
North Windows	90	0.96	1.039	93.5	
East Windows	45	0.96	1.039	46.7	
West Windows	45	0.96	1.039	46.7	
South Windows	90	0.96	1.039	93.5	
Doors	40	3.04	0.329	13.2	62
Ceiling/Attic/Roof (Notes 4a, 4b)	1539	13.44	0.074	114.6	1356
Floor (Note 4a)	1539	4.24	0.236	363.3	948
Infiltration (Note 5)					
Colorado Springs, CO				264.5	
Las Vegas, NV				306.6	
Interior Walls	1024				1425
TOTAL BUILDING					5147
Excluding Infiltration				985.1	
Including Infiltration (Colorado Springs, CO)				1249.7	
Including Infiltration (Las Vegas, NV)				1291.7	

Note 1: Changes to Case L100A are highlighted by bold font. R- and U- values include surface coefficients.

Note 2: Heat capacity includes building mass within the thermal envelope (e.g., insulation and insulation thickness of structural framing are included, exterior siding and roof/attic mass are excluded)

Note 3: Excludes area of windows and doors. ASHRAE framed area fraction of 0.25 is assumed for 2x4 16" O.C. construction.

Note 4a: ASHRAE roof/ceiling framing area fraction of 0.1 applied to both ceiling and floor.

Note 4b: Bold italic font indicates correction of Case L200A ceiling/attic/roof summary R- and U-values and related summary UA values originally published in HERS BESTEST. (Previous R- and U- values were listed as 11.75 and 0.085 respectively). This error only occurred for the Case L200A summary compilation of this table; related supplemental (more detailed) input data used to calculate ceiling/attic/roof summary data are correct for this test case. This error does not affect the example results of informative Annex B20, which all use relevant supplemental data for inputs. Revision here also addresses the minor scaled exterior film coefficient correction noted in Table 7-34.

Note 5: Infiltration UA = (infiltration mass flow)·(specific heat). Assumes air properties: specific heat = 0.240 Btu/(lb·°F); density = 0.075 lb/ft³ at sea level, adjusted for altitude per informative Annex B3, Section B3.3. The following values were used to obtain infiltration UA:

Location	ACH	Volume (ft ³)	Altitude (ft)	UA _{inf} (Btu/h·°F)
Colorado Springs	1.5	12312	6145	264.5
Las Vegas	1.5	12312	2178	306.6

TABLE 7-31 Material Descriptions, Exterior Wall—Case L200A

EXTERIOR WALL (inside to outside)						
(Note 1)	Thickness	R	U	k	DENSITY	Cp
ELEMENT (Source)	in.	$\text{h}\cdot\text{ft}^2\cdot^\circ\text{F}/\text{Btu}$	$\text{Btu}/(\text{h}\cdot\text{ft}^2\cdot^\circ\text{F})$	$\text{Btu}/(\text{h}\cdot\text{ft}\cdot^\circ\text{F})$	lb/ft^3	$\text{Btu}/(\text{lb}\cdot^\circ\text{F})$
Int Surf Coef		0.685	1.460			
Plasterboard	0.5	0.450	2.222	0.0926	50.0	0.26
Air gap (Note 2)	3.5	1.010	0.990			
Frame 2x4 16" O.C. (Note 3)	3.5	4.373	0.229	0.0667	32.0	0.33
Fiberboard sheathing	0.5	1.320	0.758	0.0316	18.0	0.31
Hardboard Siding, 7/16"	0.44	0.670	1.492	0.0544	40.0	0.28
Ext Surf Coef (Note 4)		0.174	5.748			
Total air - air, non-frame section		4.309	0.232			
Total air - air, frame section		7.672	0.130			
Total air - air, composite section	(Note 5)	4.839	0.207			
Total surf - surf, non-frame sect.		3.450	0.290			
Total surf - surf, frame section		6.813	0.147			
Total surf - surf, composite sect.	(Note 6)	3.981	0.251			

Note 1: Changes to Case L100A are highlighted in bold font.

Note 2: Non-frame (air gap) section only. See Figure 7-17 for section view of wall; air gap replaces fiberglass insulation for this case.

Note 3: Framed sections only, see Figure 7-17 for section view of wall.

Note 4: 10.7 mph wind speed and brick/rough plaster roughness; see informative Annex B4 for more on exterior film coefficients.

Note 5: Total composite R-values based on 25% frame area section per ASHRAE.

Note 6: Total surf-surf composite R-value is the total air-air composite R-value less the resistances due to the film coefficients.

TABLE 7-32 Material Descriptions, Raised Floor Exposed to Air—Case L200A

RAISED FLOOR EXPOSED TO AIR (inside to outside)						
(Note 1)	Thickness	R	U	k	DENSITY	Cp
ELEMENT	in.	$\text{h}\cdot\text{ft}^2\cdot^\circ\text{F}/\text{Btu}$	$\text{Btu}/(\text{h}\cdot\text{ft}^2\cdot^\circ\text{F})$	$\text{Btu}/(\text{h}\cdot\text{ft}\cdot^\circ\text{F})$	lb/ft^3	$\text{Btu}/(\text{lb}\cdot^\circ\text{F})$
Int Surf Coef (Note 2)		0.765	1.307			
Carpet w/ fibrous pad (Note 3)		2.080	0.481			0.34
Plywood 3/4"	0.75	0.937	1.067	0.0667	34.0	0.29
Joists 2x8 16" O.C. (Note 4)						
Ext Surf Coef (Note 5)		0.455	2.200			
Total air-air		4.237	0.236			
Total surf-surf (Note 6)		3.017	0.331			

Note 1: Changes to Case L100A are highlighted with bold font. Fiberglass insulation was deleted for this case.

Note 2: Average of ASHRAE heating and cooling coefficients.

Note 3: There is not enough information available for modeling thermal mass of carpet.

Note 4: Because there is no insulation between joists (see Figure 7-18) and they are exposed directly to ambient air, joists are assumed to be at outdoor air temperature with no insulating value and are not considered as thermal mass.

Note 5: Still air and brick/rough plaster roughness assumed; see informative Annex B4 for more about exterior film coefficients.

Note 6: Total air-air R-value less the film resistances.

TABLE 7-33 Material Description, Ceiling—Case L200A

CASE L200: CEILING (inside to outside), attic as unconditioned zone						
(Note 1)	Thickness	R	U	k	DENSITY	Cp
ELEMENT	in.	h-ft ² ·°F/ Btu	Btu/ (h-ft ² ·°F)	Btu/ (h-ft ² ·°F)	lb/ft ³	Btu/(lb·°F)
CEILING (1539 ft ² total area)						
Int Surf Coef		0.765	1.307			
Plasterboard	0.5	0.450	2.222	0.0926	50	0.26
Fiberglass batt (Note 2)	3.5	11.000	0.091	0.0265	0.6	0.2
Joists 2x6 24" O.C. (Note 3)	3.5	4.373	0.229	0.0667	32	0.33
Int Surf Coef		0.765	1.307			
Total air-air, insulated section		12.980	0.077			
Total air-air, framed section		6.353	0.157			
Total air-air, composite section	(Note 4)	11.754	0.085			
Total surf-surf, composite sec.	(Note 4)	10.224	0.098			

Note 1: Changes to Case L100A are highlighted by bold font. Use this table if attic modeled as separate zone.

Note 2: Insulated section only. See Figure 7-19 for section view of ceiling.

Note 3: Framed section only, see Figure 7-19 for section view of ceiling. Modeled framing thickness is reduced to that for insulation; remaining height above insulation is assumed to be at attic air temperature and is not considered for thermal mass.

Note 4: Based on 90% insulated section and 10% frame section per ASHRAE; applies to temperature difference between room air and attic air. The "Composite surf-surf" R-value is the composite air-air R-value less the two interior film coefficient R-values.

TABLE 7-34 Material Descriptions, Ceiling with Attic as Material Layer

CASE L200: CEILING/ATTIC/ROOF (inside to outside)						
(Note 1)	Thickness	R	U	k	DENSITY	Cp
ELEMENT	in.	h·ft ² ·°F/ Btu	Btu/ (h·ft ² ·°F)	Btu/ (h·ft·°F)	lb/ft ³	Btu/(lb·°F)
CEILING/ATTIC/ROOF						
(1539 ft ² total area, includes gables)						
Int Surf Coef		0.765	1.307			
Plasterboard	0.5	0.450	2.222	0.0926	50.0	0.26
Fiberglass batt (Note 2)	3.5	11.000	0.091	0.0265	0.6	0.20
Joists 2x6 24" O.C. (Note 3)	3.5	4.373	0.229	0.0667	32.0	0.33
Attic air (Note 4)		1.300	0.769			
Total roof deck/gable, surf-surf (Note 5)		0.899	1.112			
Ext Surf Coef (Note 6)		0.144	6.967			
SUMMARY CEILING/ATTIC/ROOF						
Total air-air, insulated section	<i>(Note 7)</i>	14.558	0.069			
Total air-air, framed section	<i>(Note 7)</i>	7.931	0.126			
Total air-air, composite section	<i>(Notes 7, 8)</i>	13.435	0.074			
Total surf-surf, composite section	<i>(Notes 7, 9)</i>	12.527	0.080			

Note 1: Changes to Case L100A are highlighted by bold font. Use this table if attic modeled as material layer.

Note 2: Insulated section only. See Figure 7-19 for section view.

Note 3: Framed section only, see Figure 7-19 for section view of ceiling/attic/roof. Thickness is the same as for insulation; remaining height above insulation is assumed to be at attic air temperature and is not considered as thermal mass.

Note 4: Average winter/summer values for natural ventilation (2.4 ach), R-11 ceiling insulation, ext abs = 0.6.

Note 5: From Table 7-7 (Case L100A).

Note 6: *Minor errata note: Original HERS BESTEST did not scale exterior film coefficient for Case L200A only, and erroneously showed scaled exterior film coefficient = 5.748 Btu/(h·ft²·F), with resulting R-composite = 13.467 Btu/(h·ft²·F) [versus corrected R-13.435] or overall 0.2% effect. Italic and bold-italic fonts indicate corrected values. This correction was propagated through to summary values in Table 7-30.*

Note 7: *Values in bold italic font are corrected from original HERS BESTEST values, applying the corrected exterior surface coefficient noted above.*

Note 8: Based on 10% frame area fraction per ASHRAE; applies to temperature difference between room air and ambient air.

Note 9: Total air-air resistance (see above) less film coefficients.

7.2.2.10 Case L202A: Low Exterior Solar Absorbance Associated with Light Exterior Surface Color. This case is **exactly as Case L200A**, except that exterior short-wave (visible and UV) absorptance (α_{ext}) is 0.2 for the following opaque exterior surfaces exposed to solar radiation:

- Exterior walls
- Roof
- End gables
- Doors.

Window frames remain at $\alpha_{ext} = 0.6$.

7.2.2.11 Slab-on-Grade Series (Cases L302A and L304A). Cases L302A and L304A are designed to compare the results of residential modeling software to example results of informative Annex B20 using the steady-state ASHRAE perimeter method for modeling slab-on-grade heat loss.^{B-7, B-8} This is a simplified method for ground-coupling analysis. It is understood that an analysis tool could use a more detailed model for slab-on-grade ground coupling, which could have a significant effect on the output. Therefore, results of alternative (somewhat more detailed) ground-coupling analysis are included for these cases as part of the example results of informative Annex B20. This serves to widen the range of example results for the slab-on-grade cases. Case descriptions for the alternative ground-coupling analysis are given in informative Annex B18, where Cases L302B and L304B are the alternative versions of cases L302A and L304A, respectively.

For Cases L302A and L304A, the ASHRAE perimeter method assumes heat loss occurs along the entire 168 ft of full slab perimeter. In both cases, an R-2.08 carpet with pad is present at the interior surface of the slab.

For these slab-on-grade cases, Case L302A is the base case for Case L304A.

7.2.2.11.1 Case L302A: Slab-on-Grade, Uninsulated ASHRAE Slab. This case is **exactly as Case L100A**, except for the following changes to output requirements and floor construction.

7.2.2.11.1.1 Output Requirements. Annual or seasonal heating loads for Colorad.TMY data are the only required outputs for cases L302A and L304A (also see Section 8.1).

7.2.2.11.1.2 Floor Construction. The raised-floor-exposed-to-air construction is changed to an uninsulated slab-on-grade construction, as shown in:

- Figure 7-20 Uninsulated Slab-on-Grade Section - Case L302A
- Table 7-35 Building Thermal Summary - Case L302A.

Note that a carpet is present on the interior surface of the slab.

The following supplemental table shows equivalent inputs for modeling the ASHRAE perimeter method with the software used to generate example results of informative Annex B20:

- Table 7-36 Material Descriptions, Slab-on-Grade Floor - Case L302A.

Because Table 7-36 contains only new information relevant to slab floor construction, it is **not** highlighted with bold font.

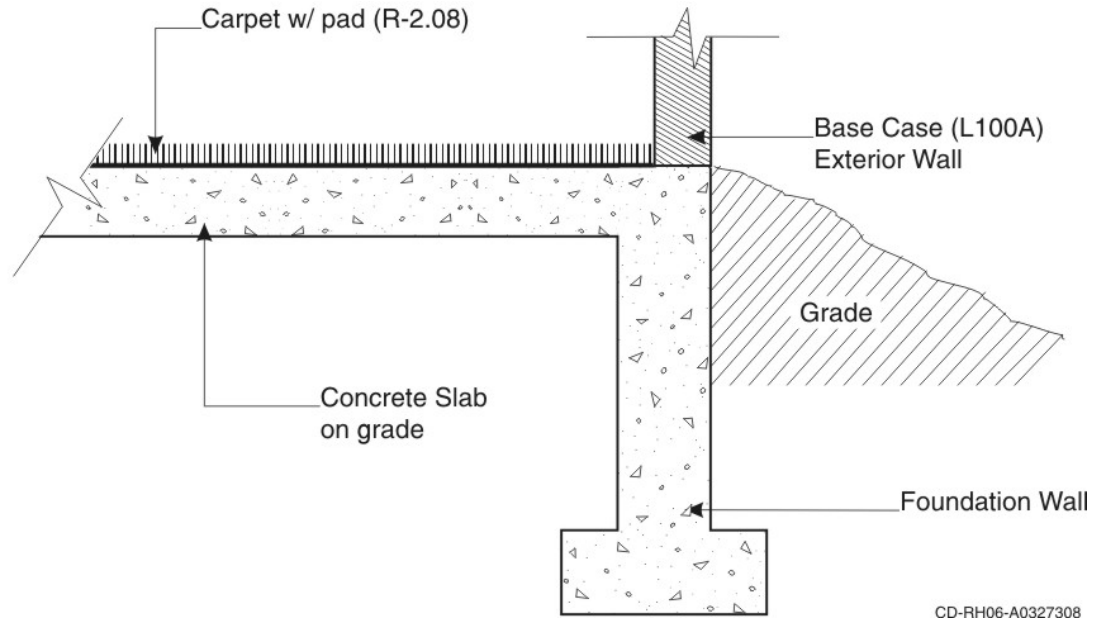

CD-RH06-A0327308

Figure 7-20 Uninsulated slab on grade, section—Case L302A.

TABLE 7-35 Building Thermal Summary—L302A

ELEMENT	AREA	R	U	UA	HEATCAP
(Note 1)	ft ²	h·ft ² ·°F/Btu	Btu/(h·ft ² ·°F)	Btu/(h·°F)	Btu/°F
					(Note 2)
Exterior Walls (Note 3)	1034	11.76	0.085	87.9	1383
North Windows	90	0.96	1.039	93.5	
East Windows	45	0.96	1.039	46.7	
West Windows	45	0.96	1.039	46.7	
South Windows	90	0.96	1.039	93.5	
Doors	40	3.04	0.329	13.2	62
Ceiling/Attic/Roof (Note 4)	1539	20.48	0.049	75.1	1665
Floor	1539	9.41	0.106	163.6	(Note 5)
Infiltration					
Colorado Springs, CO				118.2	
Interior Walls	1024				1425
TOTAL BUILDING					4535
Excluding Infiltration				620.3	
Including Infiltration (Colorado Springs, CO)				738.5	

Note 1: Changes to Case L100A are highlighted by bold font. R- and U- values include surface coefficients.

Note 2: Heat capacity includes building mass within the thermal envelope (e.g., insulation and insulation thickness of structural framing are included, exterior siding and roof/attic mass are excluded).

Note 3: Excludes the area of windows and doors. ASHRAE framed area fraction of 0.25 is assumed for 2x4 16" O.C. construction.

Note 4: ASHRAE roof/ceiling framing area fraction of 0.1 applied to ceiling.

Note 5: For the ASHRAE slab model, thermal mass effects are incorporated into steady-state heat loss coefficients.

TABLE 7-36 Material Descriptions, Slab-On-Grade Floor—Case L302A

FLOOR, SLAB-ON-GRADE, UNINSULATED ASHRAE		
ELEMENT (inside to outside)	R	U
	$\text{h}\cdot\text{ft}^2\cdot^\circ\text{F}/\text{Btu}$	$\text{Btu}/(\text{h}\cdot\text{ft}^2\cdot^\circ\text{F})$
Int Surf Coef (Note 1)	0.765	1.307
Carpet with fibrous pad	2.08	0.481
Slab Loss Coefficient (Note 2)	6.564	0.152
Total air-air	9.409	0.106

Note 1: Average of ASHRAE heating and cooling coefficients.

Note 2: This R-value is total air-air uninsulated slab R-value without carpet (based on the ASHRAE perimeter method for a metal stud wall) less the R-value of the listed interior film coefficient.

7.2.2.11.2 Case L304A: Slab-on-Grade, Insulated ASHRAE Slab. This case is **exactly as Case L302A, except** that the slab is insulated with R-5.4 perimeter insulation, as shown in:

- Figure 7-21 Slab-on-Grade with Foundation Wall Exterior Insulation, Section - Case L304A
- Table 7-37 Building Thermal Summary - Case L304A

The following supplemental table shows equivalent inputs for modeling the ASHRAE perimeter method with the software used to generate example results of informative Annex B20:

- Table 7-38. Material Descriptions, Slab-on-Grade Floor - Case L304A.

Bold font in the figure and tables for Case L304A highlights changes to Case L302A.

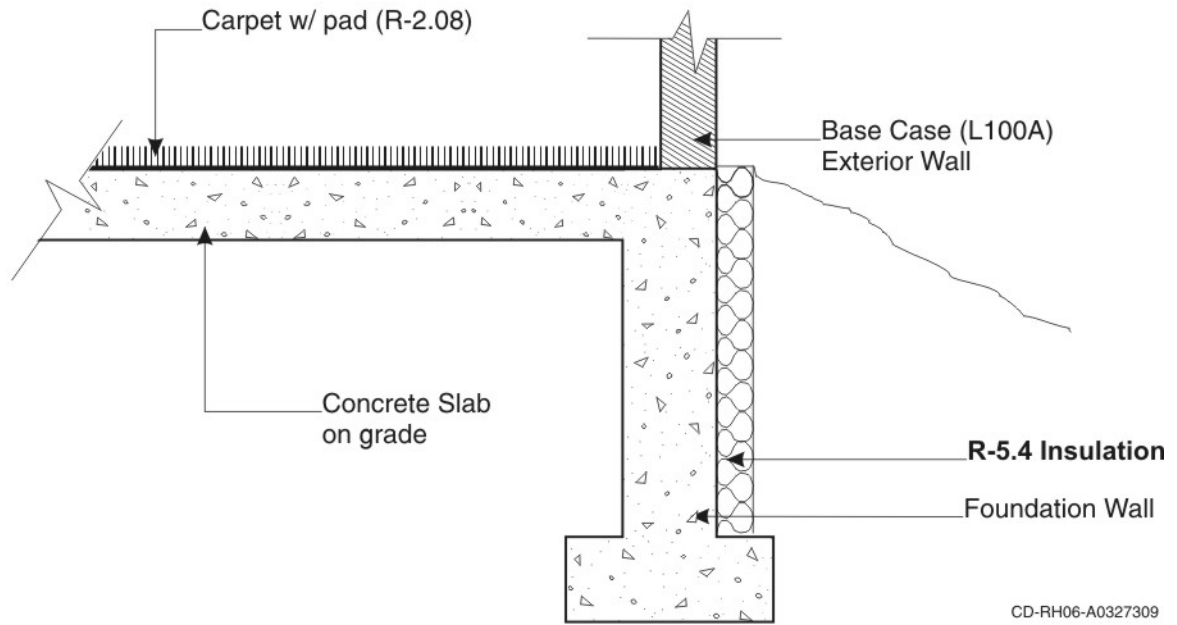

Note: Changes to Case L302A are highlighted with bold font.

Figure 7-21 Slab on grade with foundation wall exterior insulation, section—Case L304A.

TABLE 7-37 Building Thermal Summary—Case L304A

ELEMENT	AREA	R	U	UA	HEATCAP
					Btu/°F
(Note 1)	ft ²	h·ft ² ·°F/Btu	Btu/(h·ft ² ·°F)	Btu/(h·°F)	(Note 2)
Exterior Walls (Note 3)	1034	11.76	0.085	87.9	1383
North Windows	90	0.96	1.039	93.5	
East Windows	45	0.96	1.039	46.7	
West Windows	45	0.96	1.039	46.7	
South Windows	90	0.96	1.039	93.5	
Doors	40	3.04	0.329	13.2	62
Ceiling/Attic/Roof (Note 4)	1539	20.48	0.049	75.1	1665
Floor	1539	18.74	0.053	82.1	(Note 5)
Infiltration					
Colorado Springs, CO				118.2	
Interior Walls	1024				1425
TOTAL BUILDING					4535
Excluding Infiltration				538.9	
Including Infiltration (Colorado Springs, CO)				657.0	

Note 1: Changes to Case L302A are highlighted by bold font. R- and U- values include surface coefficients.

Note 2: Heat capacity includes building mass within the thermal envelope (e.g., insulation and insulation thickness of structural framing are included, exterior siding and roof/attic mass are excluded).

Note 3: Excludes the area of windows and doors. ASHRAE framed area fraction of 0.25 is assumed for 2x4 16" O.C. construction.

Note 4: ASHRAE roof/ceiling framing area fraction of 0.1 applied to ceiling.

Note 5: For the ASHRAE slab model, thermal mass effects are incorporated into steady-state heat loss coefficients.

TABLE 7-38 Material Descriptions, Slab-On-Grade Floor—Case L304A

FLOOR, SLAB ON GRADE, INSULATED ASHRAE		
(Note 1)	R	U
ELEMENT (inside to outside)	h·ft ² ·°F/Btu	Btu/(h·ft ² ·°F)
Int Surf Coef (Note 2)	0.765	1.307
Carpet with fibrous pad (ASHRAE)	2.080	0.481
Slab Loss Coefficient (Note 3)	15.891	0.063
Total air-air	18.736	0.053

Note 1: Changes to Case L302A are highlighted with bold font.

Note 2: Average of ASHRAE heating and cooling coefficients.

Note 3: This R-value is total air-air for an insulated slab (R-5.4 from edge to footer) without carpet, based on the ASHRAE perimeter method for metal stud wall construction, less the R-value of the interior film coefficient.

7.2.2.12 Basement Series (Cases L322A and L324A).

Cases L322A and L324A are designed to compare the results of residential modeling software to software used to generate example results of informative Annex B20, using the ASHRAE method for modeling basement heat loss from the below-grade basement walls and slab floor.^{B-7, B-8, B-9} It is understood that an analysis tool could use a more detailed model for basement ground coupling, which could have a significant effect on the output. Therefore, results of alternative (somewhat more detailed) ground-coupling analysis are included for these cases as part of the example results of informative Annex B20. This serves to widen the range of example results for the basement cases. Case descriptions for the alternative ground-coupling analysis are given in informative Annex B18, where Cases L322B and L324B are the alternative versions of cases L322A and L324A, respectively.

For these basement cases, Case L322A is the base case for Case L324A.

7.2.2.12.1 Case L322A: Uninsulated ASHRAE Conditioned Basement. Because this case contains numerous changes to the base building (Case L100A), a "recommended input procedure" is also included in this section.

Case L322A is **exactly as Case L100A, except** for the following changes.

7.2.2.12.1.1 Output Requirements. Annual or seasonal heating loads using Colorad.TMY data are the only required outputs for cases L322A and L324A (also see Section 8.1).

7.2.2.12.1.2 Conditioned Basement Construction. A conditioned basement has been added, with the following envelope and interior floor modifications:

- Add basement walls
- Add concrete basement floor slab
- Replace the previous main floor (formerly above raised floor exposed to air) with an interior main floor/basement ceiling.

The following figures and table (included after the discussion) contain information that is expected to be useful to most users:

- Figure 7-22 Basement Series Base Building, Section and Plan
- Figure 7-23 Basement Wall and Floor Section - Case L322A
- Figure 7-18 Raised Floor Exposed to Air - Case L200A (with change per recommended input procedure, Step 4, below)
- Table 7-39 Building Thermal Summary - Case L322A.

Relevant supplementary tables that include more detailed information are listed below. Because these tables contain only new information relevant to the basement construction, they are not highlighted with bold font.

- Table 7-40 Basement Component Surface Areas - Case L322A
- Table 7-41 Material Descriptions, Basement Wall - Case L322A
- Table 7-42 Material Descriptions, Basement Floor - Case L322A
- Table 7-43 Material Descriptions, Interior Main Floor/Basement Ceiling - Case L322A

7.2.2.12.1.3 Thermostat control and related modeling notes. Basement air temperature is regulated by the same thermostat as the main floor (see Case L100A), and main floor and basement air are assumed to be well-mixed. Therefore, model the entire house (main floor and basement) as a single zone, or model the main floor and basement as separate zones adjacent to each other with identical thermostat control. In a single-zone model, the main floor/basement ceiling is treated like the main floor interior walls. In a two-zone model, the main floor/basement ceiling is a partition between the main floor and the basement zones.

7.2.2.12.1.4 Recommended Input Procedure. To develop inputs for Case L322A, begin with Case L100A and proceed as follows:

1. Add the basement with 1539 ft² of floor area and 12312 ft³ of air volume directly below the original conditioned zone as shown in Figure 7-22. The basement wall height is 8' as shown in Figures 7-22 and 7-23. Basement envelope and ceiling component surface areas are shown in Table 7-39 (relevant supplemental data is included in Table 7-40). Thermostat control is as described in Section 7.2.1.14 above. No additional infiltration through the basement envelope is assumed (i.e., the sill is caulked).^{B-9} No additional internal gains are present in the basement.
2. Construct the basement walls as shown in Figure 7-23 and Table 7-39 (relevant supplementary tables are Table 7-40 and Table 7-41). The walls include a rim joist section, as well as above- and below-grade concrete wall sections. The basement wall construction is the same for all four basement walls. No windows are included in the basement.
3. Construct the basement floor as shown in Figures 7-22 and 7-23 and Table 7-39 (relevant supplementary tables are Tables 7-40 and 7-42).
4. Replace the base-case main floor (formerly raised floor exposed to air) with the interior main floor/basement ceiling of Table 7-39 (also see supplemental Tables 7-40 and 7-43). This floor is based on that of Figure 7-18 (Case L200A), except the exterior film below the floor is replaced by an interior film.

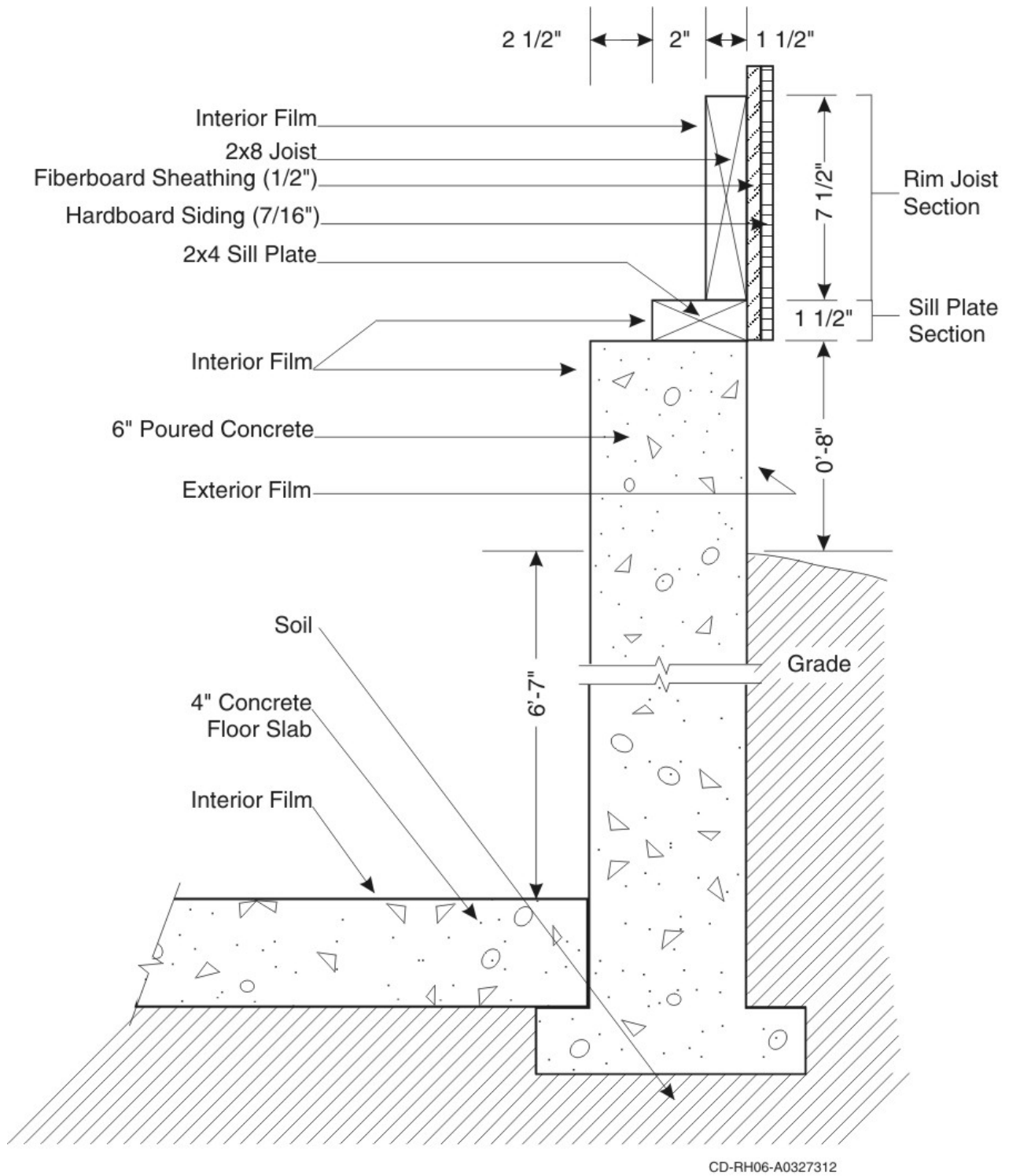

CD-RH06-A0327312

Figure 7-23 Basement wall and floor section—Case L322A.

TABLE 7-39 Building Thermal Summary—Case L322A

ELEMENT	AREA	R	U	UA	HEATCAP
					Btu/°F
(Note 1)	ft ²	h·ft ² ·°F/Btu	Btu/(h·ft ² ·°F)	Btu/(h·°F)	(Note 2)
Exterior Walls (Note 3)	1034	11.76	0.085	87.9	1383
North Windows	90	0.96	1.039	93.5	
East Windows	45	0.96	1.039	46.7	
West Windows	45	0.96	1.039	46.7	
South Windows	90	0.96	1.039	93.5	
Doors	40	3.04	0.329	13.2	62
Ceiling/Attic/Roof (Note 4)	1539	20.48	0.049	75.1	1665
Infiltration (Note 5)					
Colorado Springs, CO				118.2	
Interior Walls	1024				1425
Basement (Note 6)					
Rim Joist	126	5.01	0.200	25.1	284
Above Grade Conc. Wall	112	1.34	0.747	83.7	1568
Below Grade Conc. Wall	1106	5.87	0.170	188.4	(Note 7)
Basement Floor	1539	41.38	0.024	37.2	(Note 7)
Main Floor/Bsmnt Ceiling	1539				1930
TOTAL BUILDING					8317
Excluding Infiltration				791.1	
Including Infiltration (Colorado Springs, CO)				909.2	

Note 1: Changes to Case L100A are highlighted by bold font. R- and U- values include surface coefficients.

Note 2: Heat capacity includes building mass within the thermal envelope (e.g., insulation and insulation thickness of structural framing are included, exterior siding and roof/attic mass are excluded).

Note 3: Excludes the area of windows and doors. ASHRAE framed area fraction of 0.25 is assumed for 2x4 16" O.C. construction.

Note 4: ASHRAE roof/ceiling framing area fraction of 0.1 applied to ceiling.

Note 5: Main floor infiltration is as in Case L100A. The basement zone has no infiltration. If the basement and main floor are being modeled as one combined zone, then use an infiltration rate of 0.335 ach applied to the entire conditioned zone air volume of 24624 ft³; also see informative Annex B3 for more detail.

Note 6: Basement components are defined in Figures 7-22 and 7-23.

Note 7: For the ASHRAE below-grade wall and basement floor steady-state heat loss models, the effects of thermal mass are incorporated into the steady-state heat loss coefficients.

TABLE 7-40 Basement Component Surface Area—Case L322A

ELEMENT	HEIGHT or LENGTH ft	WIDTH ft	MULTIPLIER	AREA ft ²
MAIN FLOOR/BASEMENT CEILING				
Unframed Main Floor/Basement Ceiling (Note 1)				1385.1
Framed Main Floor/Basement Ceiling (Note 1)				153.9
RIM JOIST - NORTH/SOUTH				
Gross Wall	0.75	57.0	1.0	42.8
Joist Section (Note 2)	0.625	57.0	1.0	35.6
Sill Plate Sect. (Note 2)	0.125	57.0	1.0	7.1
RIM JOIST – EAST/WEST				
Gross Wall	0.75	27.0	1.0	20.3
Joist Section (Note 2)	0.625	27.0	1.0	16.9
Sill Plate Sect. (Note 2)	0.125	27.0	1.0	3.4
ABOVE-GRADE CONCRETE WALL - NORTH/SOUTH				
Gross Wall	0.667	57.0	1.0	38.0
ABOVE-GRADE CONCRETE WALL - EAST/WEST				
Gross Wall	0.667	27.0	1.0	18.0
BELOW-GRADE CONCRETE WALL				
Gross Wall (Note 3)	6.583	168.0	1.0	1106.0
BASEMENT FLOOR				
Concrete Slab	57.0	27.0	1.0	1539.0

Note 1: Framed floor areas are assumed to be 10% of gross areas for 2x8 16" O.C. framing. Only one side of the floor is considered for listed area. The interior floor sections are as in Figure 7-18 (Case L200A) except the exterior film coefficient is replaced by an interior film coefficient. Solar fractions for the side of this partition that serves as the main floor remain as in Case L100A. The main floor/basement ceiling has been included for the purpose of modeling the effect of its mass; it is not intended to divide the house into separately controlled zones.

Note 2: Rim joist and sill plate sections are defined in Figure 7-23.

Note 3: Width is the total perimeter length of the exterior walls.

TABLE 7-41 Material Descriptions, Basement Wall—Case L322A

BASEMENT WALL (inside to outside)						
ELEMENT	Thickness in.	R h·ft ² ·°F/Btu	U Btu/(h·ft ² ·°F)	k Btu/(h·ft·°F)	DENSITY lb/ft ³	C _p Btu/(lb·°F)
RIM JOIST ASSEMBLY						
Int Surf Coef		0.685	1.460			
Rim Joist 2x8 (Note 1)	1.5	1.874	0.534	0.0667	32.0	0.33
Sill Plate 2x4 (Note 2)	3.5	4.373	0.229	0.0667	32.0	0.33
Fiberboard sheathing	0.5	1.320	0.758	0.0316	18.0	0.31
Hardboard Siding, 7/16"	0.44	0.670	1.492	0.0544	40.0	0.28
Ext Surf Coef		0.174	5.748			
Total air - air, rim joist section		4.723	0.212			
Total air - air, sill plate section		7.222	0.138			
Total air - air, composite section (see Note 3)		5.012	0.200			
Total surf - surf, rim joist section		3.864	0.259			
Total surf - surf, sill plate section		6.363	0.157			
Total surf - surf, composite section (see Note 4)		4.153	0.241			
ABOVE-GRADE CONCRETE WALL						
Int Surf Coef		0.685	1.460			
Poured concrete	6.0	0.480	2.083	1.0417	140.0	0.20
Ext Surf Coef		0.174	5.748			
Total air - air		1.339	0.747			
BELOW-GRADE CONCRETE WALL						
Int Surf Coef		0.685	1.460			
Wall and Soil (Note 5)		5.186	0.193			
Total air - air		5.871	0.170			

Note 1: Rim joist section only. See Figure 7-23 for section view.

Note 2: Sill plate section only. See Figure 7-23 for section view.

Note 3: Total composite R-values based on 7.5" rim joist section and 1.5" sill plate section.

Note 4: Total surf-surf composite R-value is the total air-air composite R-value less the resistances caused by the film coefficients.

Note 5: This R-value is total air-air R-value (based on the ASHRAE overall steady-state heat transfer coefficient for a 6'-7" deep below-grade concrete wall) less the resistance of the listed interior film coefficient.

TABLE 7-42 Material Descriptions, Basement Floor—Case L322A

ELEMENT (inside to outside)	R	U
	h·ft ² ·°F/Btu	Btu/(h·ft ² ·°F)
Int Surf Coef (Note 1)	0.765	1.307
Below-Grade Slab and Soil (Note 2)	40.614	0.025
Total air-air	41.379	0.024

Note 1: Average of ASHRAE heating and cooling coefficients.

Note 2: This R-value is the total air-air R-value (based on the ASHRAE overall steady-state heat transfer coefficient for a 6'-7" deep below-grade concrete floor slab) less the resistance of the listed interior film coefficient.

TABLE 7-43 Material Descriptions, Interior Main Floor/Basement Ceiling—Case L322A

INTERIOR MAIN FLOOR/BASEMENT CEILING (inside to outside)						
ELEMENT	Thickness	R	U	k	DENSITY	Cp
	in.	h·ft ² ·°F/Btu	Btu/(h·ft ² ·°F)	Btu/(h·ft·°F)	lb/ft ³	Btu/(lb·°F)
Int Surf Coef (Note 1)		0.765	1.307			
Carpet w/ fibrous pad (Note 2)		2.080	0.481			
Plywood ¾"	0.75	0.937	1.067	0.0667	34.0	0.29
Joists 2x8 16" O.C. (Note 3)	7.25	9.058	0.110	0.0667	32.0	0.33
Int Surf Coef (Note 1)		0.765	1.307			

Note 1: Average of ASHRAE heating and cooling coefficients.

Note 2: There is not enough information available for dynamic modeling of carpet.

Note 3: Framed section only, use Figure 7-18 (Case L200A) floor section view; an interior film replaces the exterior film. Use framed area fraction of 0.1.

7.2.2.12.2 Case L324A: Interior Insulation Applied to Uninsulated ASHRAE Conditioned Basement Wall. This case is **exactly as Case L322A**, except that insulation has been added to the interior side of the basement wall and rim joist. The basement floor slab remains as is in Case L322A.

The following figures and table highlight information that will be useful to most users:

- Figure 7-24. Insulated Basement Wall and Rim Joist Section - Case L324A
- Figure 7-25. Insulated Basement Wall Plan Section - Case L324A
- Table 7-44. Building Thermal Summary - Case L324A.

Relevant supplementary tables that include more detailed information are:

- Table 7-45. Component Surface Areas - Case L324A
- Table 7-46. Material Descriptions, Basement Wall - Case L324A.

Bold font in figures and tables for Case L324A highlight changes relative to Case L322A.

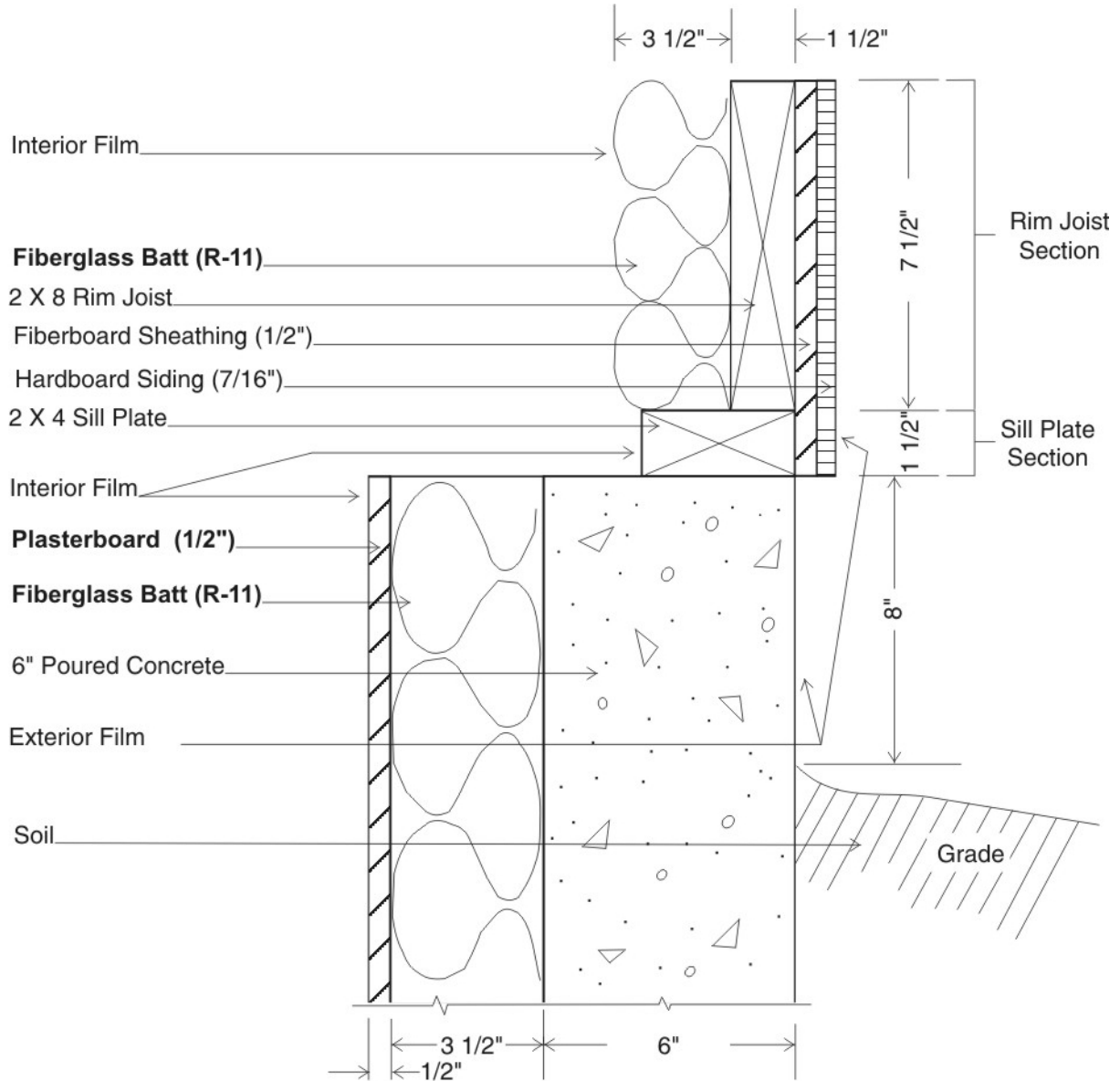

CD-RH06-A0327307

Notes: (1) Changes to case L322A are highlighted with bold font. (2) Detail showing floor joist attachment to sill plate and its effect on rim joist insulation is ignored for the purpose of this test. Use the above rim joist section for all walls, regardless of orientation.

Figure 7-24 Insulated basement wall plan section—Case L324A.

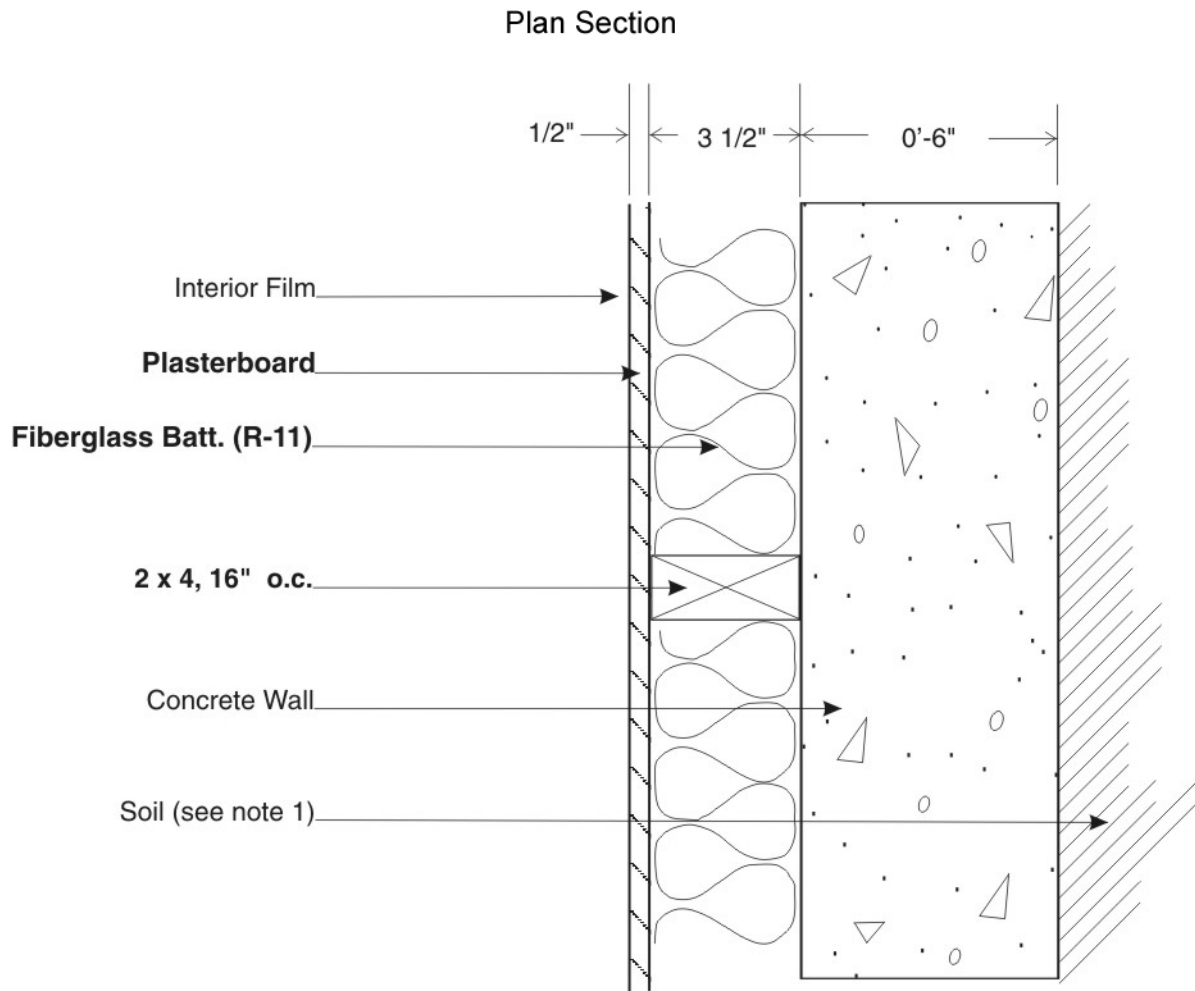

CD-RH06-A0327306

Notes: (1) Changes to case L322A are highlighted with bold font. (2) Soil does not apply to above-grade portion of basement wall. Effective soil layer thickness varies with wall depth below grade.

Figure 7-25 Insulated basement wall plan section—Case L324A.

TABLE 7-44 Building Thermal Summary—Case L324A

ELEMENT (Note 1)	AREA ft ²	R h·ft ² ·°F/Btu	U Btu/(h·ft ² ·°F)	UA Btu/(h·°F)	HEATCAP	
					(Note 2) Btu/°F	
Exterior Walls (Note 3)	1034	11.76	0.085	87.9	1383	
North Windows	90	0.96	1.039	93.5		
East Windows	45	0.96	1.039	46.7		
West Windows	45	0.96	1.039	46.7		
South Windows	90	0.96	1.039	93.5		
Doors	40	3.04	0.329	13.2	62	
Ceiling/Attic/Roof (Note 4)	1539	20.48	0.049	75.1	1665	
Infiltration						
Colorado Springs, CO				118.2		
Interior Walls	1024				1425	
Basement (Note 5)						
Rim Joist	126	13.14	0.076	9.6	68	
Above-Grade Conc. Wall	112	10.69	0.094	10.5	99 (Note 6)	
Below-Grade Conc. Wall	1106	16.31	0.061	67.8	975 (Notes 6,7)	
Basement Floor	1539	41.38	0.024	37.2	(Note 8)	
Main Floor/Bsmnt Ceiling	1539				1930	
TOTAL BUILDING					7607	
Excluding Infiltration				581.8		
Including Infiltration (Colorado Springs, CO)				700.0		

Note 1: Changes to Case L322A are highlighted by bold font. R- and U- values include surface coefficients.

Note 2: Heat capacity includes building mass within the thermal envelope (e.g., insulation and insulation thickness of structural framing are included, exterior siding and roof/attic mass are excluded).

Note 3: Excludes the area of windows and doors. ASHRAE framed area fraction of 0.25 is assumed for 2x4 16" O.C. construction.

Note 4: ASHRAE roof/ceiling framing area fraction of 0.1 applied to ceiling.

Note 5: Basement components are defined in Figure 7-24.

Note 6: Framed area fraction of 0.1 used for insulated basement wall.

Note 7: HEATCAP for below-grade basement wall includes only thermal mass associated with plasterboard, framing, and insulation.

Note 8: For the ASHRAE below-grade wall and basement floor steady-state heat loss models, the effects of thermal mass are incorporated into the steady-state heat loss coefficients.

TABLE 7-45 Component Surface Areas—Case L324A

ELEMENT	HEIGHT or LENGTH	WIDTH	MULTIPLIER	AREA
(Note 1)	ft	ft		ft ²
ABOVE-GRADE CONCRETE				
WALL - NORTH/SOUTH				
Gross Wall	0.667	57.0	1.0	38.0
Insulated Wall (Note 2)				34.2
Framed Wall (Note 2)				3.8
ABOVE-GRADE CONCRETE				
WALL - EAST/WEST				
Gross Wall	0.667	27.0	1.0	18.0
Insulated Wall (Note 2)				16.2
Framed Wall (Note 2)				1.8
BELOW-GRADE CONCRETE WALL				
Gross Wall (Note 3)	6.583	168.0	1.0	1106.0
Insulated Wall (Note 2)				995.4
Framed Wall (Note 2)				110.6

Note 1: Changes to Case L322A are highlighted with bold font.

Note 2: 10% framed area fraction is assumed for non-structural wall framing.

Note 3: Width is the total perimeter length of the exterior walls.

TABLE 7-46 Material Descriptions, Basement Wall—Case L324A

INSULATED BASEMENT WALL (inside to outside)

(Note 1)	Thickness	R	U	k	DENSITY	Cp
ELEMENT	in.	h·ft ² ·°F/Btu	Btu/(h·ft ² ·°F)	Btu/(h·ft·°F)	lb/ft ³	Btu/(lb·°F)
RIM JOIST ASSEMBLY						
Int Surf Coef		0.685	1.460			
Rim Joist 2x8 (Note 2)	1.5	1.874	0.534	0.0667	32.0	0.33
Fiberglass batt (Note 2)	3.5	11.000	0.091	0.0265	0.6	0.20
Sill Plate 2x4 (Note 3)	3.5	4.373	0.229	0.0667	32.0	0.33
Fiberboard sheathing	0.5	1.320	0.758	0.0316	18.0	0.31
Hardboard Siding, 7/16"	0.4375	0.670	1.492	0.0544	40.0	0.28
Ext Surf Coef		0.174	5.748			
Total air - air, rim joist section		15.723	0.064			
Total air - air, sill plate section		7.222	0.138			
Total air - air, composite section		13.144	0.076			
(see Note 4)						
Total surf - surf, rim joist section		14.864	0.067			
Total surf - surf, sill plate section		6.363	0.157			
Total surf - surf, composite section		12.285	0.081			
(see Note 5)						
ABOVE-GRADE CONCRETE WALL						
Int Surf Coef		0.685	1.460			
Plasterboard	0.5	0.450	2.222	0.0926	50.0	0.26
Fiberglass batt (Note 6)	3.5	11.000	0.091	0.0265	0.6	0.20
Frame 2x4, 16" O.C. (Note 7)	3.5	4.373	0.229	0.0667	32.0	0.33
Poured concrete	6.0	0.480	2.083	1.0417	140.0	0.20
Ext Surf Coef		0.174	5.748			
Total air - air, insulated section		12.789	0.078			
Total air - air, frame section		6.162	0.162			
Total air - air, composite section		11.547	0.087			
(see Note 8)						
Total surf - surf, insulated section		11.930	0.084			
Total surf - surf, frame section		5.303	0.189			
Total air - air, composite section		10.688	0.094			
(see Note 5)						
BELOW-GRADE CONCRETE WALL						
Int Surf Coef (ASHRAE)		0.685	1.460			
Plasterboard	0.5	0.450	2.222	0.0926	50.0	0.26
Fiberglass batt (Note 6)	3.5	11.000	0.091	0.0265	0.6	0.20
Frame 2x4, 16" O.C. (Note 7)	3.5	4.373	0.229	0.0667	32.0	0.33
Wall and Soil (Note 9)		5.186	0.193			
Total air - air, insulated section		17.321	0.058			
Total air - air, frame section		10.694	0.094			
Total air - air, composite section		16.311	0.061			
(see Note 8)						

Note 1: Changes to Case L322A are highlighted with bold font.

Note 2: Rim joist section only, see Figure 7-24 for section view of rim joist.

Note 3: Sill plate section only.

Note 4: Total composite R-values based on 7.5" rim joist section and 1.5" sill plate section.

Note 5: Total surf-surf composite R-value is the total air-air composite R-value less the resistances caused by the film coefficients.

Note 6: Insulated section only.

Note 7: Framed section only.

Note 8: Total composite R-values from 90% insulated area section 10% frame area section for nonstructural framing.

Note 9: This R-value is total air-air R-value from Case L322A (based on the ASHRAE overall steady-state heat transfer coefficient for a 6'-7" deep below-grade concrete wall) less the resistance of the listed interior film coefficient.

7.2.3 Tier-2 Test Cases. This section describes revisions to the base building required to model the Tier-2 cases. Case L165A is based on Tier 1 Case L160A, and Case P100A is based on Tier 1 Case L120A. Case P100A represents the base case for the other P-series cases (P105A, P110A, P140A, P150A). Bold font in tables and figures for the Tier 2 cases denotes changes with respect to their appropriate base cases.

Where applicable, summary figures and tables are listed first, with supplementary tables listed afterward.

7.2.3.1 Case L165A: East/West Shaded Windows. Case L165A is **exactly as Case L160A, except** that an opaque overhang and ten opaque fins are added to the east and west walls, as shown in Figure 7-26.

Depending on the input capabilities of the software being tested, it may not be possible to model the exact geometry of the windows and shading devices as shown in Figure 7-26. If this is the case, a nearly equivalent model of the shading devices may be used such as that described in Figure 7-27, where the ten small fins have been replaced with two large fins. It may also be necessary to modify the window geometry. This type of modification process was also presented with Figure 7-14 for Case L155A.

Recall that, as explained in Section 7.1, this test requires use of consistent modeling methods for the test cases.

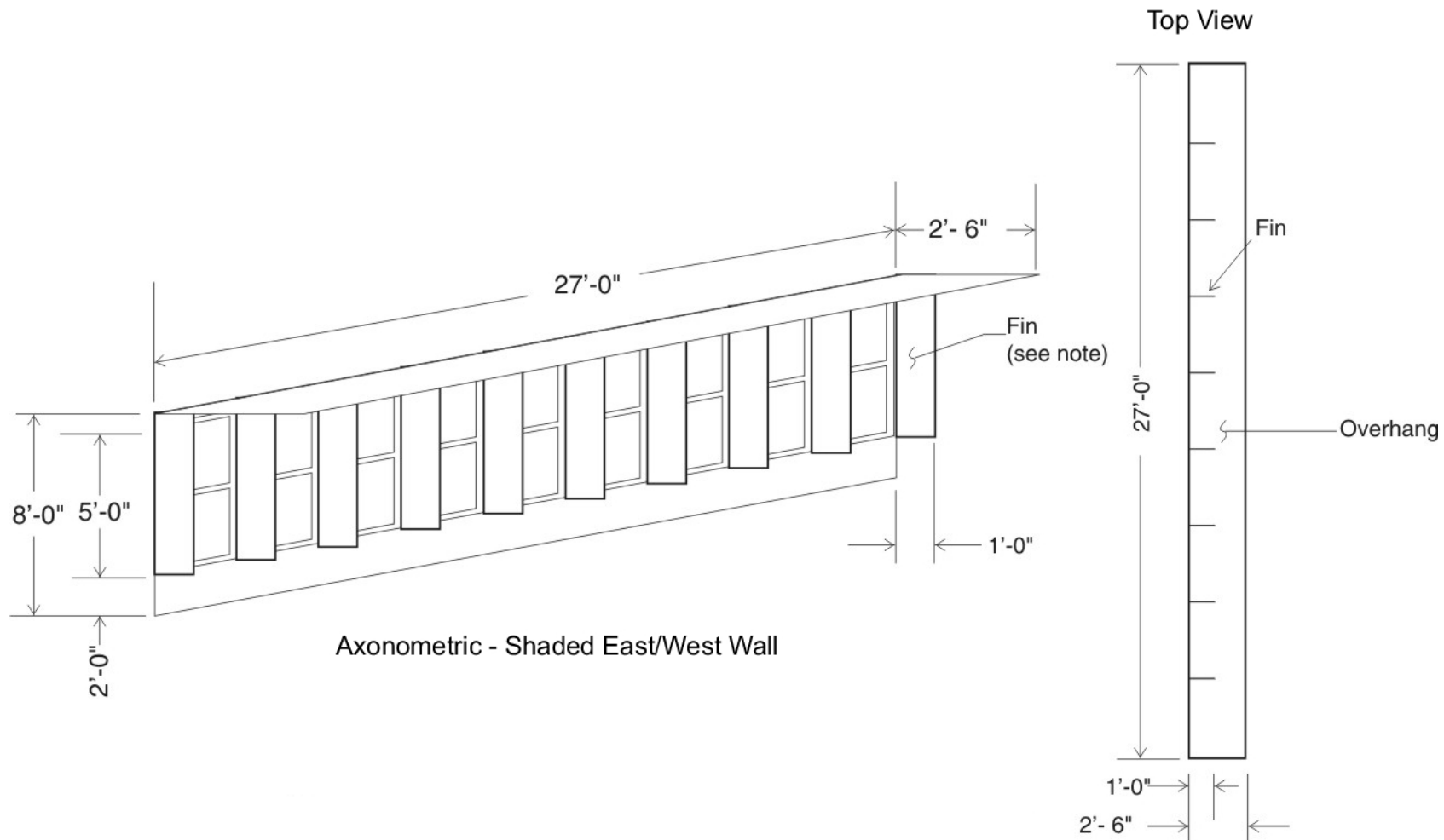

Note: Typical fin is 1' wide and 6' high. Plane of fin is perpendicular to plane of Wall. Typical window module is as in Figure 7-8.

CD-RH06-A0327335

Figure 7-26 Overhang and fins for east and west windows—Case L165A.

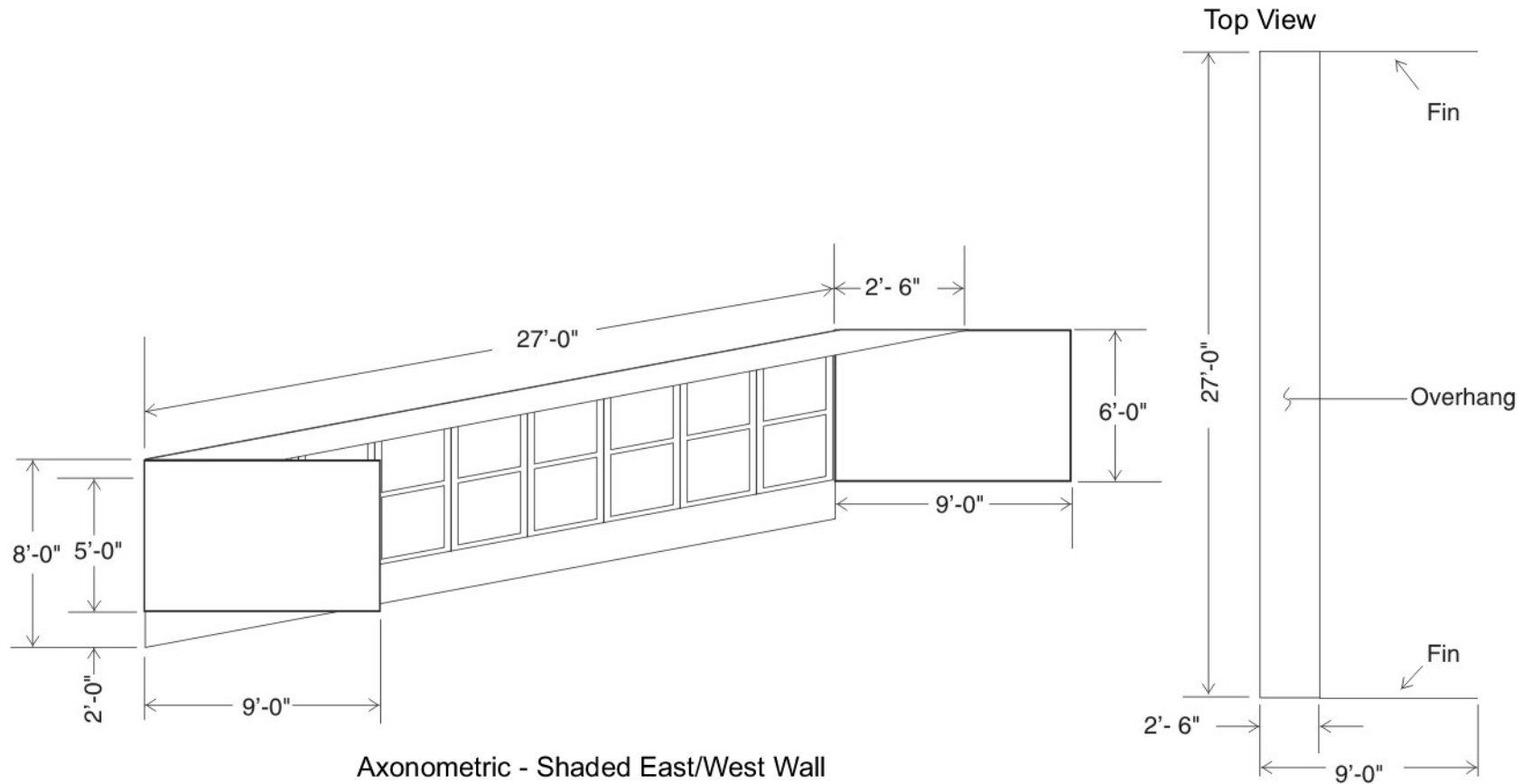

Axonometric - Shaded East/West Wall

CD-RH06-A0327334

Note: Typical window module is as in Figure 7-8.

Figure 7-27 Overhang and fins for east and west windows alternate arrangement—Case L165A.

7.2.3.2 Case P100A: Passive Solar Base Case (Unshaded). Case P100A is the base case for the passive solar series (P-series) cases. This case is representative of good passive solar heating design. However, for the passive base case, a south wall overhang was not included. To prevent summer overheating, good passive-solar design would include an overhang as described in Case P105A.

Case P100A is **based on Case L120A**, with modifications as described below. Because of the many changes in this case versus Case L120A, it is recommended that inputs for Case P100A be double-checked and results disagreements diagnosed before running the remainder of the P-series cases. A "recommended input procedure" is also included.

The following **modifications to Case L120A** are required to achieve Case P100A.

7.2.3.2.1 Weather Data and Output Requirements. Both the annual or seasonal heating and sensible cooling load outputs for the P-series cases are generated using only the Colorad.TMY weather data (also see Section 8.2). As noted in Section 7.2.3.2.4 below, two separate simulations are required: one for calculating heating loads, and the other for calculating cooling loads.

7.2.3.2.2 Construction Details. Qualitative summary (quantitative details follow below):

- All south window orientation with increased glass area
- Clear double-pane window with wood frame and modified geometry
- R-23 composite floor with brick pavers for thermal mass
- Replacement of three of the 14' lightweight interior walls with three 14' double brick walls for thermal mass.

The following tables and figures highlight information that is expected to be useful to most users.

- Figure 7-9 Exterior Wall Section - Case L120A
- Figure 7-28 Window, Door, and Mass Wall Locations - Case P100A
- Figure 7-29 Mass Raised Floor Exposed to Air, Section - Case P100A
- Figure 7-30 Interior Mass Wall Section - Case P100A
- Figure 7-31 Window Detail, Vertical Slider 30" Wide by 78" High with 2 3/4" Frame - Case P100A
- Table 7-47 Building Thermal Summary - Case P100A.

Relevant supplementary tables that include more detailed information are:

- Table 7-16 Material Descriptions, Exterior Wall - Case L120A
- Table 7-48 Component Surface Areas and Solar Fractions - Case P100A
- Table 7-49 Material Descriptions, Raised Floor Exposed to Air - Case P100A
- Table 7-50 Material Descriptions, Interior Mass Wall - Case P100A
- Table 7-51 Window Summary, Double Pane, Clear, Wood Frame Window - Case P100A
- Table 7-52 Glazing Summary, Clear Double Pane Center of Glass Values - Case P100A

- Table 7-53 Optical Properties as a Function of Incidence Angle for Clear Double-Pane Glazing - Case P100A.

Where appropriate, changes to Case L120A have been highlighted in tables and figures with bold font.

7.2.3.2.3 Radiative Properties of Massive Surfaces. For massive (brick) surfaces, solar absorptance and infrared emittance are 0.6 and 0.9 respectively (same as other surfaces).

7.2.3.2.4 Thermostat Control Strategies. Use the annual thermostat control settings noted below for the P-series cases.

Heating only:

HEAT = ON IF **TEMP** < 68°F; COOL = OFF.

Cooling only:

COOL = ON IF **TEMP** > 78°F; HEAT = OFF.

Note: "TEMP" refers to conditioned zone air temperature.

Because this is not deadband thermostat control, separate simulations for heating and cooling outputs were required to generate example results (just as with the Tier 1 cases when Lasvega.TMY was the cooling climate). Proper comparison with example results requires separate simulations with the tool/software being tested for generating annual (or seasonal) heating and cooling outputs.

7.2.3.2.5 Interior Walls. As in the Tier 1 tests, interior walls (including massive interior walls) have been included for the purpose of modeling their mass effect. They are not intended to divide the conditioned zone into separately controlled zones.

7.2.3.2.6 Raised Floor Exposed to Air. To simulate a raised floor exposed to air, the test cases require the following assumptions:

- raised floor air temperature is assumed to equal outdoor air temperature
- the underside of the conditioned-zone floor has an exterior film coefficient of 2.2 Btu/(h·ft²·°F), consistent with a "rough" surface texture and zero windspeed; if the program being tested cannot set the exterior surface coefficient to a fixed value, then allow exterior surface coefficient to vary with wind speed.
- the conditioned-zone floor exterior surface (surface facing the raised floor) receives no solar radiation.

See Section 7.2.1.5 (Case L100A) for further instructions about how to model these assumptions.

7.2.3.2.7 Interior Solar Distribution. Interior solar distribution is calculated as shown in informative Annex B19. This represents a more detailed treatment appropriate to passive solar design.

7.2.3.2.8 Recommended Input Procedure. To develop inputs for Case P100A, **begin with Case L120A** and proceed as follows.

1. Remove all window assemblies from the north, east, and west walls and replace them with the Case L120A solid exterior wall material described in Figure 7-9 and Table

- 7-16 (Case L120A). Resulting component surface areas and solar fractions are shown in Table 7-48.
2. Move the door from the south wall to the east wall as shown in Figure 7-28. Material properties of doors are unchanged. Resulting component surface areas and solar fractions are shown in Table 7-48.
 3. Construct the south wall as shown in Figure 7-28 and Table 7-48. All windows are clear double-pane with wood frame and are located on the south wall. The gross window area (including frames) is 325 ft². The window unit size was modified so that more glazing could be applied to the south wall. The resulting changes in overall (glass plus frame) window properties are described in Figure 7-31 and Table 7-47, and in greater detail in Tables 7-51 through 7-53. Because of the large amount of window area, the only place for batt insulation (see insulated wall section of Figure 7-9 and Table 7-16) is above the window headers, the remaining portion of the south wall uses only the framed wall section from Figure 7-9 and Table 7-16. Resulting component surface areas and solar fractions are shown in Table 7-48.
 4. Replace the L120A floor with the raised floor exposed to air described in Figure 7-29 and Table 7-49. (For the purpose of this test, the floor structure is assumed to be sufficient to support the brick pavers without modification.) Resulting component surface areas and solar fractions are shown in Table 7-48.
 5. Replace the three 14-ft low-mass interior walls with the double-brick walls as shown in Figure 7-28. The double-brick interior wall materials are described in Figure 7-30 and Table 7-50. All other lightweight interior walls remain as located in Figure 7-2 (Case L100A). Resulting component surface areas and solar fractions are shown in Table 7-48.

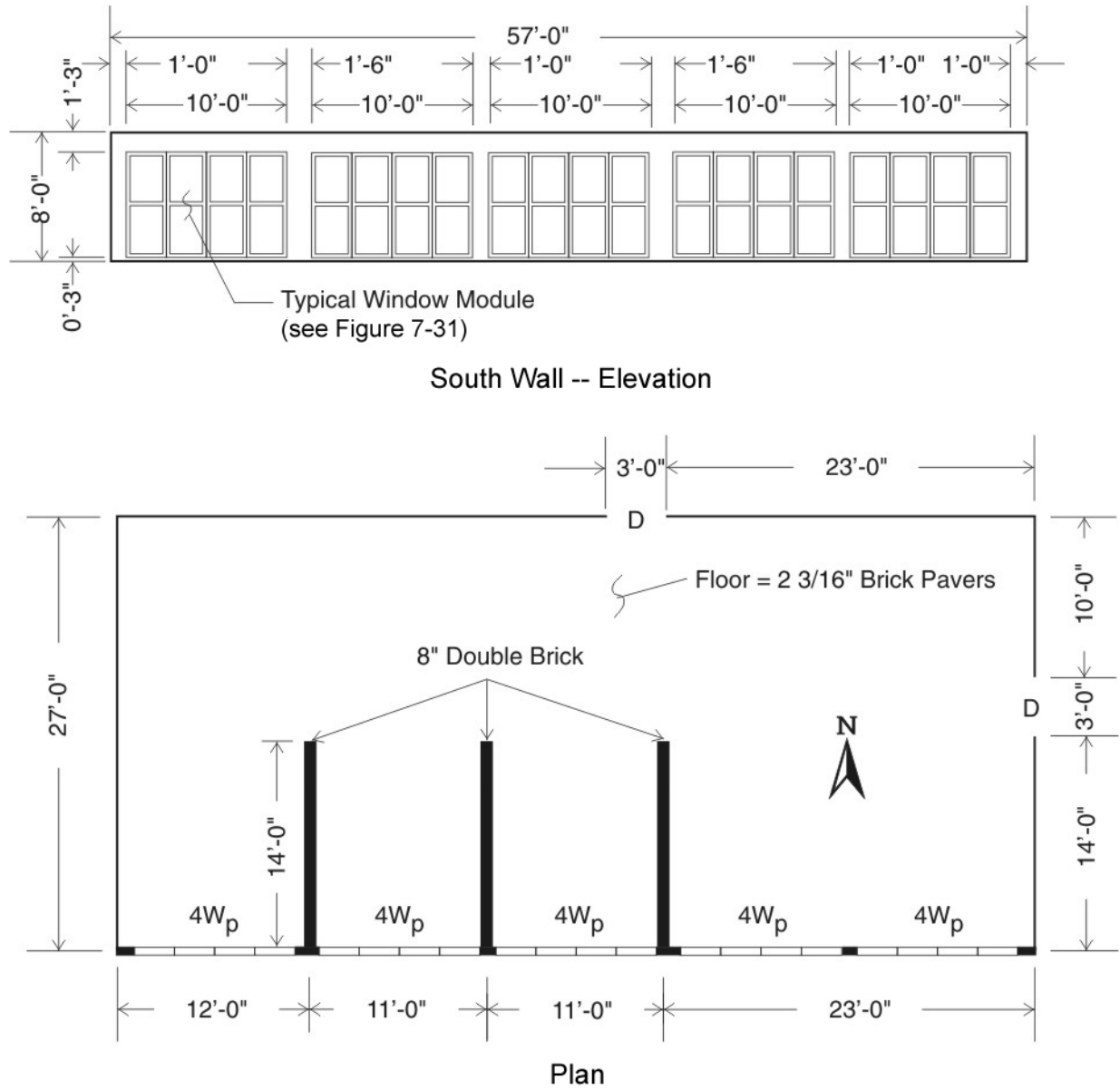

CD-RH06-A0327326

Legend:

- #W_p:
 - W_p = window (2'6" wide × 6'6" high), see Figure 7-31
 - # = number of windows along given length of exterior wall
- D = solid-core wood door (3' wide × 6'8" high)

Note: 8" brick interior walls replace low-mass interior walls of Figure 7-2; all other interior walls of Figure 7-2 remain as is.

Figure 7-28 Window, door, and mass wall locations—Case P100A.

Note: Changes to Case L120A are highlighted with bold font.

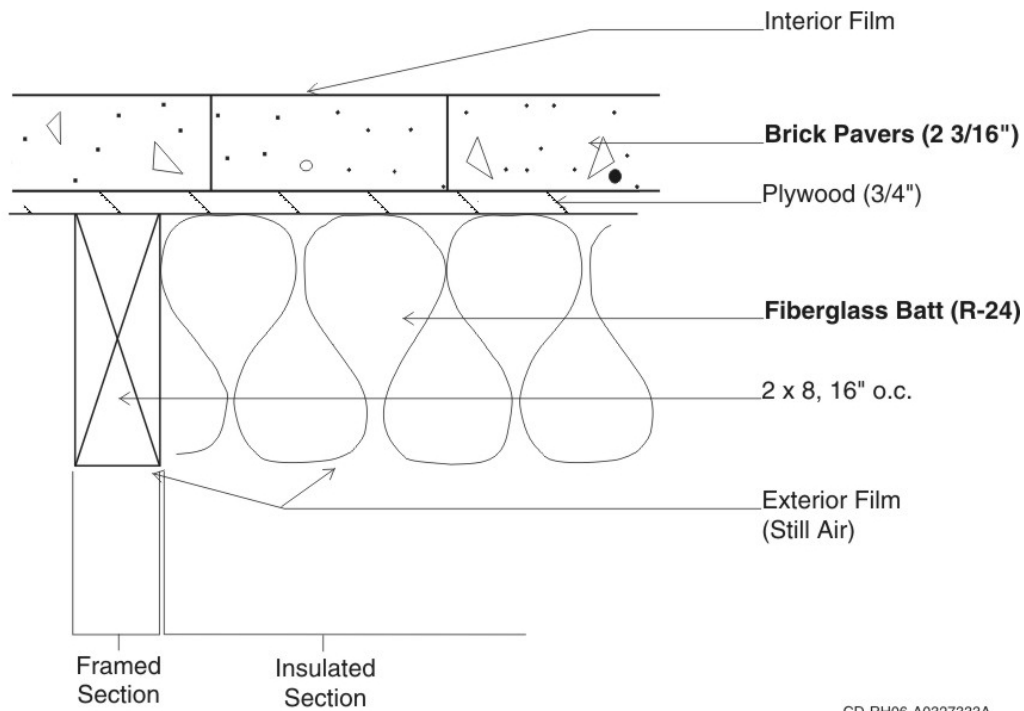

CD-RH06-A0327333A

Figure 7-29 Mass raised floor exposed to air, section—Case P100A.

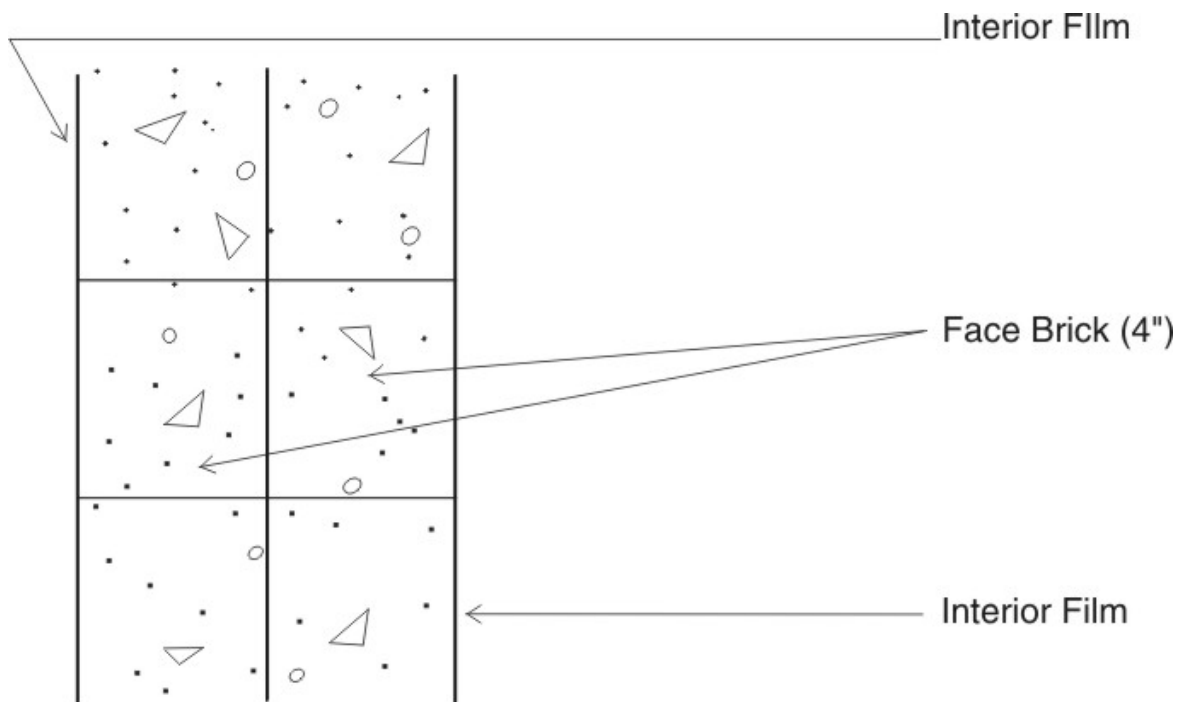

CD-RH06-A0327333B

Figure 7-30 Interior mass wall section—Case P100A.

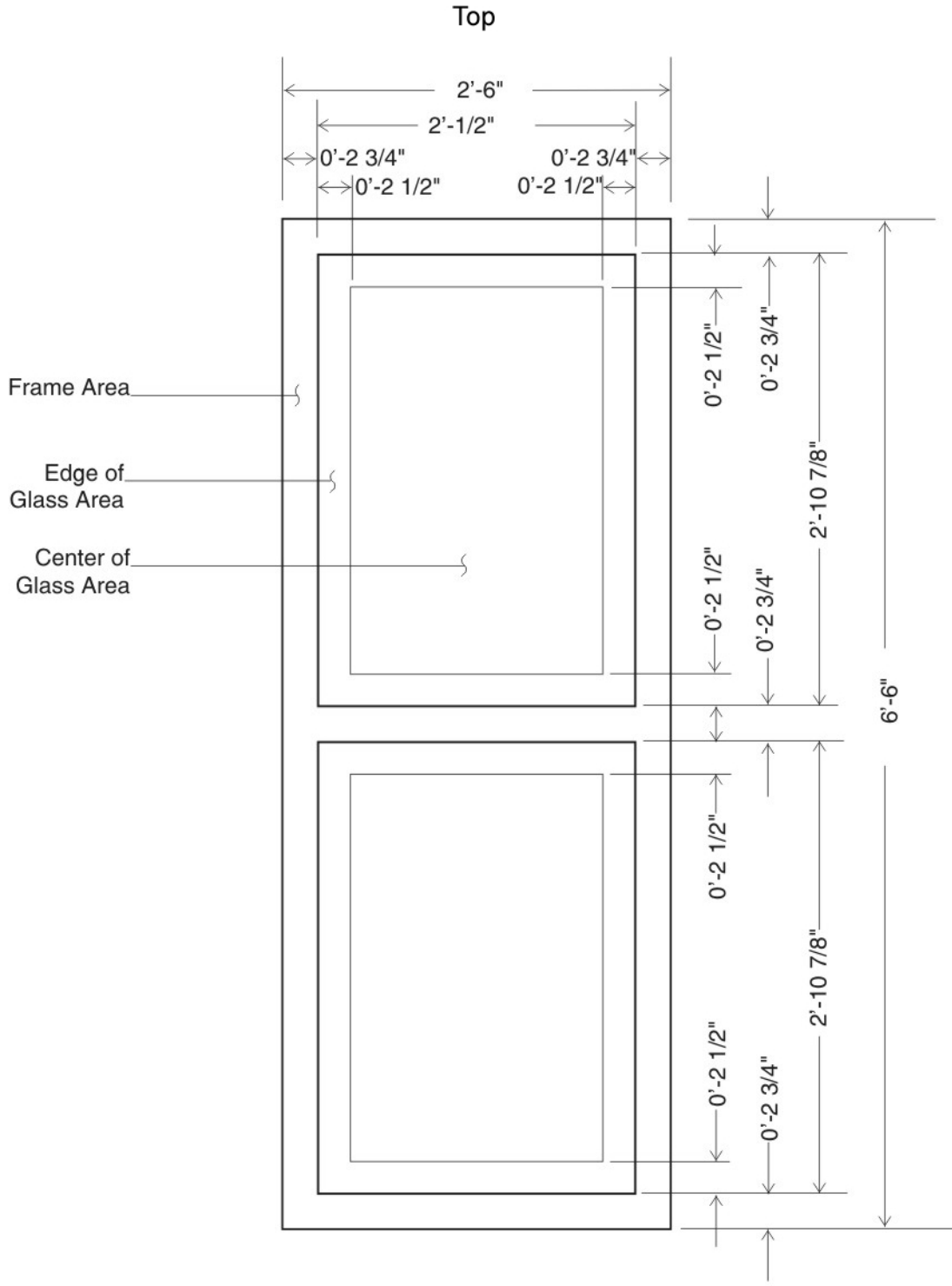

CD-RH06-A0327325

Figure 7-31 Window detail, vertical slider 30" wide by 78" high with 2 3/4" frame—Case P100A.

TABLE 7-47 Building Thermal Summary—Case P100A

ELEMENT	AREA ft ²	R h·ft ² ·°F/Btu	U Btu/(h·ft ² ·°F)	UA Btu/(h·°F)	HEATCAP Btu/°F
(Note 1)		(Note 2)	(Note 2)	(Note 2)	(Note 3)
N/E/W Ext Walls (Note 4)	848	23.58	0.042	36.0	1435
Doors	40	3.04	0.329	13.2	62
South Windows (Note 5)	325	1.96	0.510	165.7	
South Ext Insulated Wall	50	27.18	0.037	1.8	32
South Ext Framed Wall	81	16.05	0.062	5.0	441
Ceiling/Attic/Roof (Note 6)	1539	59.53	0.017	25.9	1850
Floor (Note 6)	1539	23.35	0.043	65.9	11131
Infiltration					
Colorado Springs, CO				118.2	
Interior Low Mass Walls	688				957
Interior High Mass Walls	336				6989
TOTAL BUILDING					22896
Excluding Infiltration				313.5	
Including Infiltration (Colorado Springs, CO)				431.7	
WINDOW SUMMARY: DOUBLE PANE, WOOD FRAME WITH METAL SPACER					
(Note 7)	Area ft ²	U Btu/(h·ft ² ·°F)	SHGC (dir. nor.)	Trans. (dir. nor.)	SC (Note 10)
		(Note 2)	(Note 8)	(Note 9)	
Glass pane	11.87	0.516	0.760	0.705	0.887
Wood frame w/ metal spacer	4.38	0.492			
Window, composite	16.25	0.510	0.577	0.515	0.672
PASSIVE SOLAR DESIGN SUMMARY (Note 11)					
	Net south glass area	S.GL.A/ Floor A	Heatcap/ S.GL.A	Mass A/ S.GL.A	LCR (Note 12)
	ft ²		Btu/(ft ² ·°F)		Btu/(day·°F·ft ²)
	237	0.154	96.5	7.90	31.3

Note 1: Changes to Case L120A are highlighted by bold font.

Note 2: Includes interior and exterior surface coefficients.

Note 3: Heat capacity includes building mass within the thermal envelope (e.g., insulation and insulation thickness of structural framing are included, exterior siding and roof/attic mass are excluded).

Note 4: Excludes area of doors. ASHRAE framed area fraction of 0.22 used for 2x6 24" O.C. construction.

Note 5: Window area and other properties are for glass and frame combined. The accompanying window summary disaggregates glass and frame properties for a single window unit. The south wall contains 20 window units.

Note 6: ASHRAE roof/ceiling framing area fraction of 0.1 used for both ceiling and floor.

Note 7: This data summarizes one complete detailed window unit per Figure 7-31 and Tables 7-51 through 7-53.

Note 8: SHGC is the Solar Heat Gain Coefficient which includes the inward flowing fraction of absorbed direct normal solar radiation in addition to direct normal transmittance. For more detail, see ASHRAE 1993 Fundamentals, chp. 27 (Reference B-7).

Note 9: "Trans." is the direct normal transmittance.

Note 10: Shading coefficient (SC) is the ratio of direct normal SHGC for a specific glazing unit to direct normal SHGC for the WINDOW 4.1 reference glazing unit.

Note 11: This case is representative of good passive solar design. However, an optimized passive solar design would include more glass (less window frame) area than is given here, with a corresponding increase in the mass surface area, and an overhang per Case P105A.

Note 12: LCR is Load to Collector area Ratio, calculated from:

$$([Total\ building\ UA\ including\ infiltration] - [south\ glass\ UA]) \times (24\ h/day) / (south\ glass\ area).$$

TABLE 7-48 Component Surface Areas and Solar Fractions—Case P100A

ELEMENT (Note 1)	HEIGHT or LENGTH ft	WIDTH ft	MULTIPLIER	AREA ft ²	INSIDE SOLAR FRACTION
EXTERIOR SOUTH WALL					(Note 2)
Gross Wall	8.0	57.0	1.0	456.0	
Gross Window	6.5	2.5	20.0	325.0	
Window Frame Only			20.0	87.7	0.0065
Insulated L120A Wall	(Note 3)			50.0	0.0037
Framed L120A Wall	(Note 3)			81.0	0.0060
EXTERIOR NORTH WALL					
Gross Wall	8.0	57.0	1.0	456.0	
Door	6.67	3.0	1.0	20.0	0.0015
Insulated L120A Wall	(Note 4)			340.1	0.0251
Framed L120A Wall	(Note 4)			95.9	0.0071
EXTERIOR EAST WALL					
Gross Wall	8.0	27.0	1.0	216.0	
Door	6.67	3.0	1.0	20.0	0.0015
Insulated L120A Wall	(Note 4)			152.9	0.0113
Framed L120A Wall	(Note 4)			43.1	0.0032
EXTERIOR WEST WALL					
Gross Wall	8.0	27.0	1.0	216.0	
Insulated L120A Wall	(Note 4)			168.5	0.0124
Framed L120A Wall	(Note 4)			47.5	0.0035
CEILING					
Gross Ceiling	57.0	27.0	1.0	1539.0	
Insulated Ceiling	(Note 5)			1385.1	0.1022
Framed Ceiling	(Note 5)			153.9	0.0114

TABLE 7-48 Component Surface Areas and Solar Fractions—Case P100A (continued)

ELEMENT (Note 1)	HEIGHT or LENGTH ft	WIDTH ft	MULTIPLIER	AREA ft ²	INSIDE SOLAR FRACTION
FLOOR					
Gross Floor	57.0	27.0	1.0	1539.0	
Insulated Floor	(Note 5)			1385.1	0.2689
Framed Floor	(Note 5)			153.9	0.0299
INTERIOR WALLS					
Gross Wall (Note 6)	8.0	128.0		1024.0	
Mass Wall (Note 6)	8.0	14.0	3.0	336.0	0.1028
Unframed Wall	(Note 6)			619.2	0.0457
Framed Wall	(Note 6)			68.8	0.0051
TRANSMITTED SOLAR, INTERIOR DISTRIBUTION SUMMARY					
Total Opaque Interior Surface Area (Note 7)				6232.7	0.8010
Solar to Air (or low-mass furnishings)					0.1750
Solar Lost (back out through windows)					0.0240 (Note 8)

Note 1: Changes to Case L120A are highlighted with bold font.

Note 2: Calculation of Inside Solar Fractions for Case P100A is described in informative Annex B19.

Note 3: Because of the large amount of glazing on the south wall (see Figure 7-28), the only place for batt insulation is above the window headers; remaining wall area contains only the framed section of Figure 7-9 (Case L120A).

Note 4: Insulated and framed exterior wall sections are defined in Figure 7-9 (Case L120A). ASHRAE framed area fraction of 0.22 is assumed for 2x6 24" O.C. construction.

Note 5: Insulated and framed floor and ceiling sections are defined in Figures 7-29 and 7-10 (Case L120A) respectively. ASHRAE roof/ceiling framing area fraction of 0.1 applied to both ceiling and floor.

Note 6: Width is the length of interior walls from Figure 7-2 (Case L100A) and Figure 7-28. Framed wall area is assumed to be 10% of gross wall area for 2x4 16" O.C. framing. Only one side of the wall is considered for listed area. This area is multiplied by 2 to determine solar fractions. Solar fractions shown are for just one side of the wall. Interior walls within the conditioned zone have been included for the purpose of modeling the effect of their mass. They are not intended to divide the conditioned zone into separately controlled zones.

Note 7: Total area of just those surfaces to which an inside solar fraction is applied.

Note 8: Calculated using the algorithm described in informative Annex B7, Section B7.2.

TABLE 7-49 Material Descriptions, Raised Floor Exposed to Air—Case P100A

RAISED FLOOR EXPOSED TO AIR (inside to outside)						
(Note 1)	Thickness	R	U	k	DENSITY	Cp
ELEMENT	in.	h·ft ² ·°F/Btu	Btu/(h·ft ² ·°F)	Btu/(h·ft·°F)	lb/ft ³	Btu/(lb·°F)
Int Surf Coef (Note 2)		0.765	1.307			
Brick Pavers	2.19	0.243	4.114	0.7500	135.0	0.24
Plywood 3/4"	0.75	0.937	1.067	0.0667	34.0	0.29
Fiberglas batt (Note 3)	7.25	24.000	0.042	0.0252	0.66	0.20
Joists 2x8 16" O.C. (Note 4)	7.25	9.058	0.110	0.0667	32.0	0.33
Ext Surf Coef (Note 5)		0.455	2.200			
Total air-air, insulated section		26.400	0.038			
Total air-air, frame section		11.458	0.087			
Total air-air, composite section (Note 6)		23.354	0.043			
Total surf-surf, composite section (Note 7)		22.134	0.045			

Note 1: Changes to Case L120A highlighted by bold font.

Note 2: Average of ASHRAE heating and cooling coefficients.

Note 3: Insulated section only, see Figure 7-29 for section view of floor. Properties account for compression of 8" batt into 7.25" cavity.

Note 4: Framed section only, see Figure 7-29 for section view of floor.

Note 5: Still air and brick/rough plaster roughness assumed; see informative Annex B4 for exterior film coefficient as a function of windspeed and surface roughness. This coefficient is applied to entire floor area (1539 ft²).

Note 6: ASHRAE roof/ceiling framing area fraction of 0.1 applied.

Note 7: Total air-air composite R-value less the film resistances.

TABLE 7-50 Material Descriptions, Interior Mass Wall—Case P100A

INTERIOR MASS WALL						
(Note 1)	Thickness	R	U	k	DENSITY	Cp
ELEMENT (Source)	in.	h·ft ² ·°F/Btu	Btu/(h·ft ² ·°F)	Btu/(h·ft·°F)	lb/ft ³	Btu/(lb·°F)
Int Surf Coef		0.685	1.460			
Face Brick	4.0	0.444	2.250	0.7500	130.0	0.24
Face Brick	4.0	0.444	2.250	0.7500	130.0	0.24
Int Surf Coef		0.685	1.460			

Note 1: Changes to Case L120A are highlighted by bold font; change only mass walls designated in Figure 7-28.

TABLE 7-51 Window Summary, Double-Pane, Clear, Wood Frame Window—Case P100A

Property	Value	Units	Notes
GENERAL PROPERTIES			
Area, gross window	16.25	ft ²	(Note 1)
Width, frame	2.75	in.	
Area, frame	4.38	ft ²	
Area, edge of glass (EOG)	3.78	ft ²	
Area, center of glass (COG)	8.09	ft ²	
Area, net glass	11.87	ft ²	(Area,EOG + Area,COG)
OPTICAL PROPERTIES			
Absorptance, frame	0.60		
Transmittance, frame	0.00		
COG/EOG optical properties	(see Table 7-52)		(Note 2)
Solar Heat Gain Coefficient (SHGC), gross window	0.577		(Note 3)
Shading Coefficient (SC), gross window	0.672		(Note 3)
Dividers, curtains, blinds, and other obstructions in window	None		
THERMAL PROPERTIES (conductances/resistances include film coefficients)			
Conductance, frame (R-Value)	0.492 2.031	Btu/(h·ft ² ·°F) h·ft ² ·°F/Btu	Wood frame with metal spacer (Note 4)
Conductance, edge of glass (R-Value)	0.588 1.700	Btu/(h·ft ² ·°F) h·ft ² ·°F/Btu	
Conductance, center of glass (R-Value)	0.483 2.070	Btu/(h·ft ² ·°F) h·ft ² ·°F/Btu	
Conductance, net glass (R-Value)	0.516 1.936	Btu/(h·ft ² ·°F) h·ft ² ·°F/Btu	(Note 5)
Conductance, gross window (R-Value)	0.510 1.961	Btu/(h·ft ² ·°F) h·ft ² ·°F/Btu	(Note 6)
COMBINED SURFACE COEFFICIENT CONDUCTANCES			
Exterior Surf Coef, glass and frame	4.226	Btu/(h·ft ² ·°F)	based on output of WINDOW 4.1
Interior Surface Coefficient, glass	1.397	Btu/(h·ft ² ·°F)	based on output of WINDOW 4.1
Interior Surface Coefficient, frame	1.460	Btu/(h·ft ² ·°F)	from ASHRAE

Note 1: Area for one representative window unit. See Figure 7-31 for schematic representation of frame, center-of-glass (COG) and edge-of-glass (EOG) areas. Gross window area is the sum of frame, COG, and EOG areas.

Note 2: Edge-of-glass optical properties are the same as the center-of-glass optical properties. Table 7-53 gives optical properties as a function of incidence angle.

Note 3: These are overall window (COG, EOG, and frame) properties for direct normal solar radiation.

Note 4: The frame conductance presented here is based on the ASHRAE value for operable two-pane window with wood/vinyl frame and metal spacer adjusted for the exterior surface coefficients also shown in this table. Material properties for dynamic modeling of window frames (density, specific heat, etc.) are not given.

Note 5: Net glass conductance includes only the COG and EOG portions of the window.

Note 6: Gross window conductance includes the frame, EOG, and COG portions of the window.

TABLE 7-52 Glazing Summary, Clear Double Pane Center-of-Glass Values—Case P100A

Property	Value	Units
GENERAL PROPERTIES		
Number of Panes	2	
Pane Thickness	0.118	in.
Air Gap Thickness	0.500	in.
SINGLE PANE OPTICAL PROP.		
	(Note 1)	
Transmittance	0.837	
Reflectance	0.075	
Absorptance	0.088	
Index of Refraction	1.5223	
Extinction Coefficient	0.7806	/in.
DOUBLE PANE OPTICAL PROP.		
Transmittance	0.705	
Reflectance	0.128	
Absorptance (outer pane)	0.094	
Absorptance (inner pane)	0.074	
Solar Heat Gain Coefficient (SHGC)	0.760	
Shading Coefficient (SC)	0.887	
Optical Properties as a Function of Incident Angle	(See Table 7-53)	
THERMAL PROPERTIES		
Conductivity of Glass	0.520	Btu/(h·ft·°F)
Combined Radiative and Convective Coefficient of Air Gap (R-Value)	0.926 1.080	Btu/(h·ft ² ·°F) h·ft ² ·°F/Btu
Conductance of Glass Pane (R-Value)	52.881 0.019	Btu/(h·ft ² ·°F) h·ft ² ·°F/Btu
Exterior Combined Surface Coef. (R-Value)	4.226 0.237	Btu/(h·ft ² ·°F) h·ft ² ·°F/Btu
Interior Combined Surface Coef. (R-Value)	1.397 0.716	Btu/(h·ft ² ·°F) h·ft ² ·°F/Btu
U-Value, Air-Air (R-Value)	0.483 2.070	Btu/(h·ft ² ·°F) h·ft ² ·°F/Btu
Hemispherical Infrared Emittance	0.84	
Infrared Transmittance	0.0	
Density of Glass	154.0	lb/ft ³
Specific Heat of Glass	0.18	Btu/(lb·°F)

Note 1: Optical properties listed in this table are for direct normal radiation.

TABLE 7-53 Optical Properties as a Function of Incidence Angle for Clear Double-Pane Glazing—Case P100A

Angle	Properties (Notes 1, 2)				
	Trans	Refl	Abs Out	Abs In	SHGC
0	0.705	0.128	0.094	0.074	0.760
10	0.704	0.128	0.094	0.074	0.759
20	0.700	0.128	0.096	0.076	0.757
30	0.693	0.130	0.099	0.078	0.751
40	0.678	0.139	0.103	0.080	0.738
50	0.646	0.164	0.109	0.081	0.708
60	0.577	0.226	0.117	0.081	0.639
70	0.436	0.363	0.127	0.074	0.495
80	0.204	0.608	0.133	0.055	0.252
90	0.000	1.000	0.000	0.000	0.000
Hemis	0.601	0.205	0.108	0.076	0.659

Note 1: Trans = Transmittance, Refl = Reflectance, Abs Out = Absorptance of outer pane, Abs In = Absorptance of inner pane, SHGC = Solar Heat Gain Coefficient, Hemis = Hemispherically integrated property. Transmittance, reflectance, and SHGC are overall properties for the entire glazing system (excluding the frame).

Note 2: Output is from WINDOW 4.1. SHGC accounts for surface coefficients and is based on wind speed of 10.7 mph.

7.2.3.3 Case P105A: Passive Solar with Overhang. Case P105A is **exactly as Case P100A, except** that a south wall opaque overhang is included that extends outward horizontally 3.47 ft with vertical offset of 2.08 ft from the top of the window (0.83 ft from the top of the wall) as shown in Figure 7-32. The overhang traverses the entire length of the south wall. (Overhang width and offset are based on full shading for a summer noon solar altitude angle of 68°, and no shading for a winter noon solar altitude angle of 31°.) Window locations remain as shown in Figure 7-28 (Case P100A).

Depending on the input capabilities of the software being tested, it may not be possible to model the exact geometries of

the windows and overhang as shown in Figures 7-28 and 7-32. If this is the case, a simplified model of the south wall may be used, such as the conceptual description shown in Figure 7-33. Proper dimensions for this example would be obtained using Figure 7-28, Figure 7-31 and Table 7-48 (see Case P100A). While the overhang is not shown in Figure 7-33, it must be included as shown in Figure 7-32.

Recall that, as explained in Section 7.1, this test requires use of consistent modeling methods for the test cases.

South Wall Section

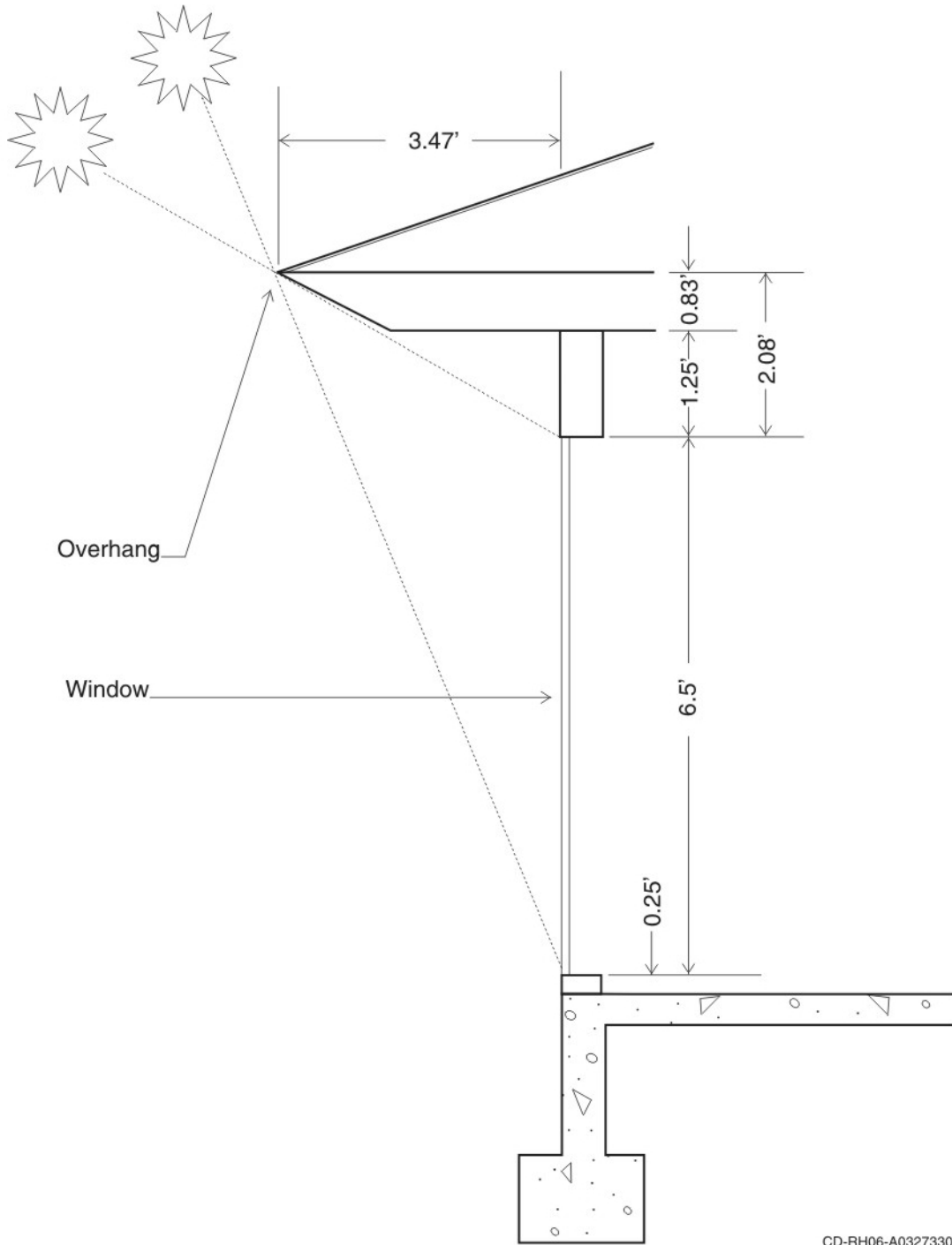

CD-RH06-A0327330

Notes: Overhang traverses entire length of south wall.
Attic/roof geometry variation shown here is only for the purpose of locating the overhang. Thermal modeling of the attic/roof assembly remains as in Case LI20A.

Figure 7-32 South overhang—Case P105A.

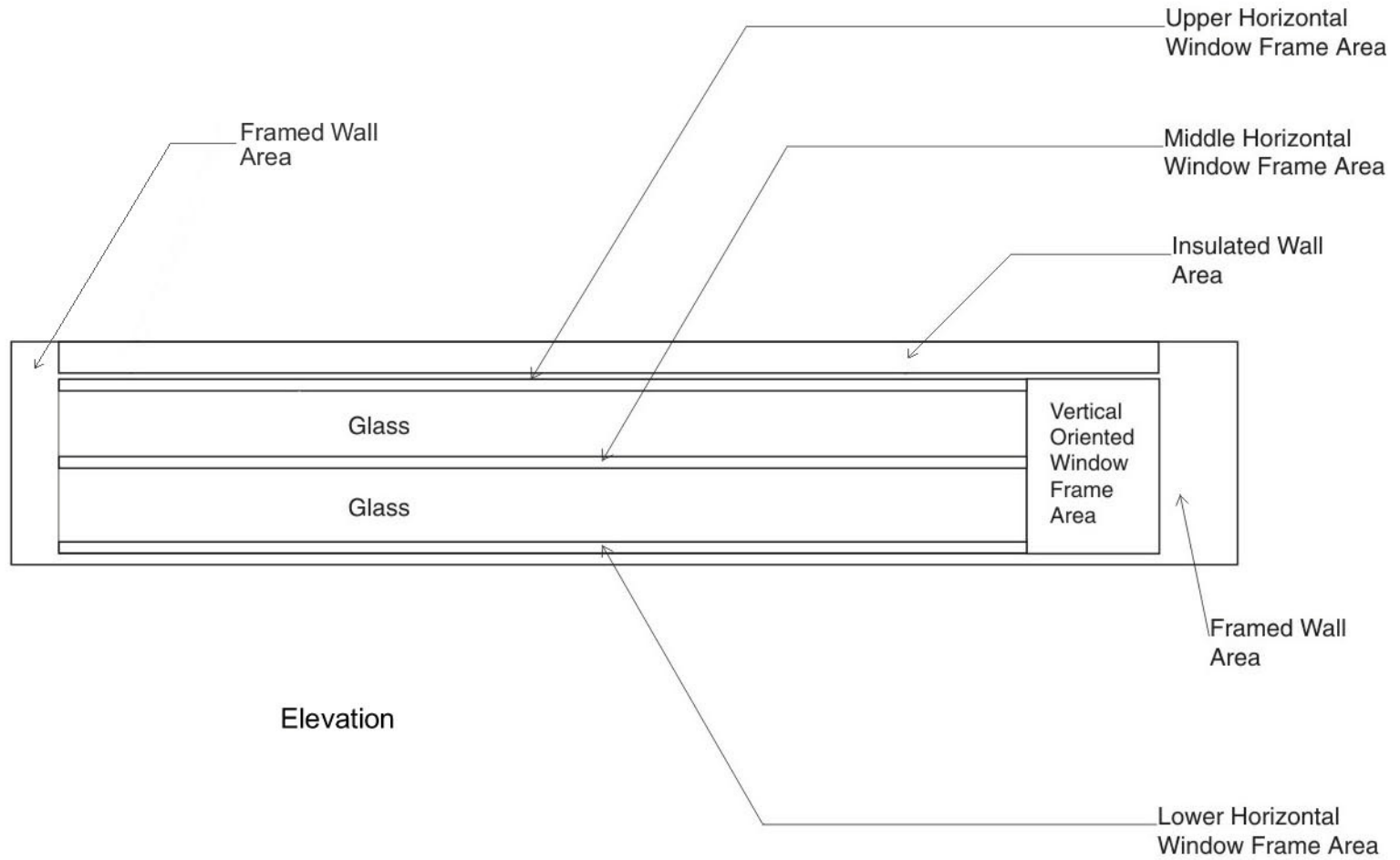

CD-RH06-A0327328

Figure 7-33 Example model of south wall for simulating south overhang effect in Case P105A.

7.2.3.4 Case P110A: Low-Mass Version of Case P100A. Case P110A is **exactly as Case P100A, except** for the following changes. The brick pavers have been removed from the floor and replaced with an equivalent resistance massless floor covering. Also, the three massive interior walls have been replaced with low-mass interior walls such that all interior walls are now configured as in Case L100A (Tier 1 base case).

The following figures and tables highlight these changes:

- Figure 7-7 Interior Wall Plan Section - Case L100A
- Figure 7-34 Raised Floor Exposed to Air, Section - Case P110A
- Table 7-8 Material Descriptions, Interior Wall - Case L100A
- Table 7-54 Building Thermal Summary - Case P110A
- Table 7-55 Component Surface Areas and Solar Fractions - Case P110A
- Table 7-56 Material Descriptions, Raised Floor Exposed to Air - Case P110A.

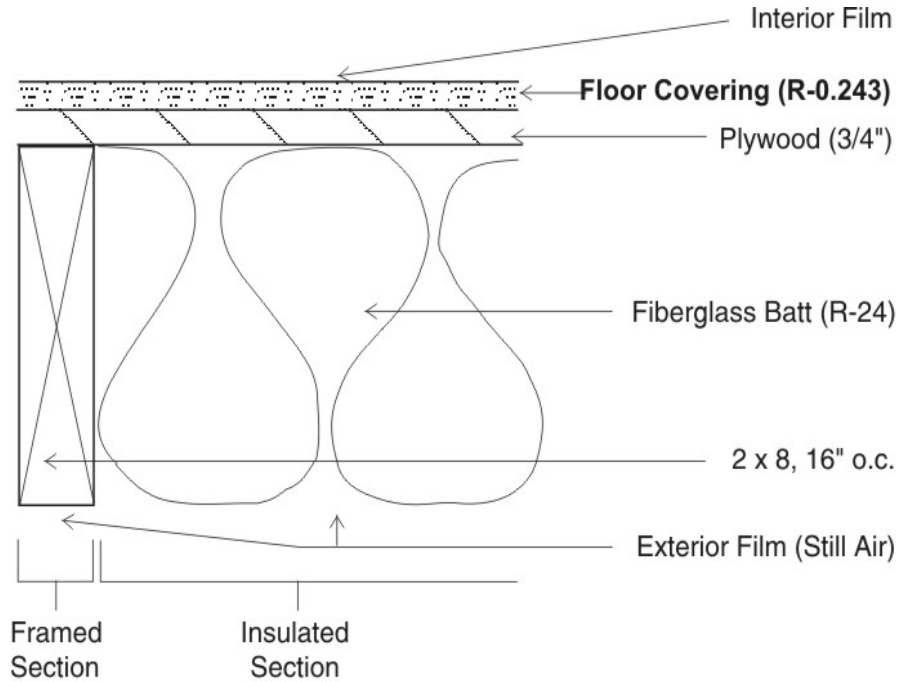

CD-RH06-A0327336

Figure 7-34 Raised floor exposed to air, section—Case P110A.

TABLE 7-54 Building Thermal Summary—Case P110A

ELEMENT	AREA ft ²	R h·ft ² ·°F/Btu	U Btu/(h·ft ² ·°F)	UA Btu/(h·°F)	HEATCAP Btu/°F
(Note 1)		(Note 2)	(Note 2)	(Note 2)	(Note 3)
N/E/W Ext Walls (Note 4)	848	23.58	0.042	36.0	1435
Doors	40	3.04	0.329	13.2	62
South Windows (Note 5)	325	1.96	0.510	165.7	
South Ext Insulated Wall	50	27.18	0.037	1.8	32
South Ext Framed Wall	81	16.05	0.062	5.0	441
Ceiling/Attic/Roof (Note 6)	1539	59.53	0.017	25.9	1850
Floor (Note 6)	1539	23.35	0.043	65.9	2041
Infiltration					
Colorado Springs, CO				118.2	
Interior Low Mass Walls	1024				1425
TOTAL BUILDING					
Excluding Infiltration				313.5	
Including Infiltration (Colorado Springs, CO)				431.7	

PASSIVE SOLAR DESIGN SUMMARY

Net south glass area ft ²	S.GL.A/ Floor A	Heatcap/ S.GL.A Btu/(°F·ft ²)	Mass A/ S.GL.A	LCR (Note 7) Btu/(day·°F·ft ²)
237	0.154	30.7	0.0	31.3

Note 1: Changes to Case P100A are highlighted by bold font.

Note 2: Includes interior and exterior surface coefficients.

Note 3: Heat capacity includes building mass within the thermal envelope (e.g., insulation and insulation thickness of structural framing are included, exterior siding and roof/attic mass are excluded).

Note 4: Excludes area of doors. ASHRAE framed area fraction of 0.22 used for 2x6 24" O.C. construction.

Note 5: Window area and other properties are for glass and frame combined.

Note 6: ASHRAE roof/ceiling framing area fraction of 0.1 used for both ceiling and floor.

Note 7: LCR is Load to Collector area Ratio, calculated from: $([\text{Total building UA including infiltration}] - [\text{south glass UA}]) \times (24 \text{ h/day}) / (\text{south glass area})$.

TABLE 7-55 Component Surface Areas and Solar Fractions—Case P110A

ELEMENT	HEIGHT or LENGTH ft	WIDTH ft	AREA ft ²	INSIDE SOLAR FRACTION
(Note 1)				
INTERIOR WALLS				
Gross Wall (Note 2)	8.0	128.0	1024.0	
Unframed Wall (Note 2)			921.6	0.1382
Framed Wall (Note 2)			102.4	0.0154

Note 1: Changes to Case P100A are highlighted with bold font.

Note 2: Width is the total length of all interior walls from Figure 7-2 (Case L100A). Framed wall area is assumed to be 10% of gross wall area for 2x4 16" O.C. framing. Only one side of the wall is considered for listed area. This area is multiplied by 2 to determine solar fractions. Solar fractions shown are for just one side of the wall. Interior walls within the conditioned zone have been included for the purpose of modeling the effect of their mass. They are not intended to divide the conditioned zone into separately controlled zones.

TABLE 7-56 Material Descriptions, Raised Floor Exposed to Air—Case P110A

RAISED FLOOR (inside to outside)						
ELEMENT	Thickness	R	U	k	DENSITY	Cp
(Note 1)	in.	h·ft ² ·°F/Btu	Btu/(h·ft ² ·°F)	Btu/(h·ft·°F)	lb/ft ³	Btu/(lb·°F)
Int Surf Coef (Note 2)		0.765	1.307			
Floor Covering (Note 3)		0.243	4.114			
Plywood 3/4"	0.75	0.937	1.067	0.0667	34.0	0.29
Fiberglass batt (Note 4)	7.25	24.000	0.042	0.0252	0.66	0.20
Joists 2x8 16" O.C. (Note 5)	7.25	9.058	0.110	0.0667	32.0	0.29
Ext Surf Coef (Note 6)		0.455	2.200			
Total air-air, insulated section		26.400	0.038			
Total air-air, frame section		11.458	0.087			
Total air-air, composite section (Note 7)		23.354	0.043			
Total surf-surf, composite section (Note 8)		22.134	0.045			

Note 1: Changes to Case P100A highlighted by bold font.

Note 2: Average of ASHRAE heating and cooling coefficients.

Note 3: This floor covering (see Figure 7-34) is included so that the steady-state air-air composite floor conductance is the same as for the high-mass passive-solar floor. "Floor Covering" replaces "Brick Pavers" in Figure 7-29 (Case P100A).

Note 4: Insulated section only, see Figure 7-34 for section view of floor. Properties account for compression of 8" batt into 7.25" cavity.

Note 5: Framed section only, see Figure 7-34 for section view of floor.

Note 6: Still air and brick/rough plaster roughness assumed; see informative Annex B4 for exterior film coefficient as a function of windspeed and surface roughness. This coefficient is applied to entire floor area (1539 ft²).

Note 7: Calculated value, ASHRAE roof/ceiling framing area fraction of 0.1 applied.

Note 8: Total air-air composite R-value less the film resistances.

7.2.3.5 Case P140A: Zero Window Area Version of Case P100A. Case P140A is **exactly as Case P100A, except** the glazing is removed from the south wall such that the entire south wall is opaque with material properties per Figure 7-9 (Case L120A) and Table 7-16 (Case L120A).

The following tables summarize the changes:

- Table 7-57 Building Thermal Summary - Case P140A
- Table 7-58 Component Surface Areas - Case P140A

TABLE 7-57 Building Thermal Summary—Case P140A

ELEMENT	AREA ft ²	R h·ft ² ·°F/Btu	U Btu/(h·ft ² ·°F)	UA Btu/(h·°F)	HEATCAP Btu/°F
(Note 1)		(Note 2)	(Note 2)	(Note 2)	(Note 3)
Exterior Walls (Note 4)	1304	23.58	0.042	55.3	2206
Doors	40	3.04	0.329	13.2	62
Ceiling/Attic/Roof (Note 5)	1539	59.53	0.017	25.9	1850
Floor (Note 5)	1539	23.35	0.043	65.9	11131
Infiltration					
Colorado Springs, CO				118.2	
Interior Low Mass Walls	688				957
Interior High Mass Walls	336				6989
TOTAL BUILDING					23194
Excluding Infiltration				160.2	
Including Infiltration (Colorado Springs, CO)				278.4	

PASSIVE SOLAR DESIGN SUMMARY

Net south glass area ft ²	S.G.L.A./ Floor A	Heatcap/ S.G.L.A. Btu/(°F·ft ²)	Mass A/ S.G.L.A.	LCR Btu/(day·°F·ft ²)
0.0	0.0	N/A	N/A	N/A

Note 1: Changes to Case P100A are highlighted by bold font. Windows have been removed from the south wall.

Note 2: Includes interior and exterior surface coefficients.

Note 3: Heat capacity includes building mass within the thermal envelope (e.g., insulation and insulation thickness of structural framing are included, exterior siding and roof/attic mass are excluded).

Note 4: Excludes area of doors. ASHRAE framed area fraction of 0.22 used for 2x6 24" O.C. construction.

Note 5: ASHRAE roof/ceiling framing area fraction of 0.1 used for both ceiling and floor.

TABLE 7-58 Component Surface Areas—Case P140A

ELEMENT	HEIGHT or LENGTH ft	WIDTH ft	MULTIPLIER	AREA ft ²
(Note 1)				
EXTERIOR SOUTH WALL				
Gross Wall	8.0	57.0	1.0	456.0
Insulated L120A Wall (Note 2)				355.7
Framed L120A Wall (Note 2)				100.3

Note 1: Changes to Case P100A are highlighted with bold font.

Note 2: Insulated and framed exterior wall sections are defined in Figure 7-9 (Case L120A). ASHRAE framed area fraction of 0.22 is assumed for 2x6 24" O.C. construction.

7.2.3.6 Case P150A: Even Window Distribution Version of Case P100A. This case is **exactly as Case P100A, except** that all windows are evenly distributed among the walls. Interior walls are as in Case P100A. These changes are summarized in the following:

- Figure 7-35 Window Locations - Case P150A
- Table 7-59 Building Thermal Summary - Case P150A

- Table 7-60 Component Surface Areas and Solar Fractions - Case P150A.

The calculation of interior solar distribution fractions in Table 7-60 assumes that solar energy transmitted through windows, and not absorbed by lightweight furnishings or lost due to cavity albedo, is distributed to all interior surfaces in proportion to their areas. Solar lost (cavity albedo) remains as for Case P100A.

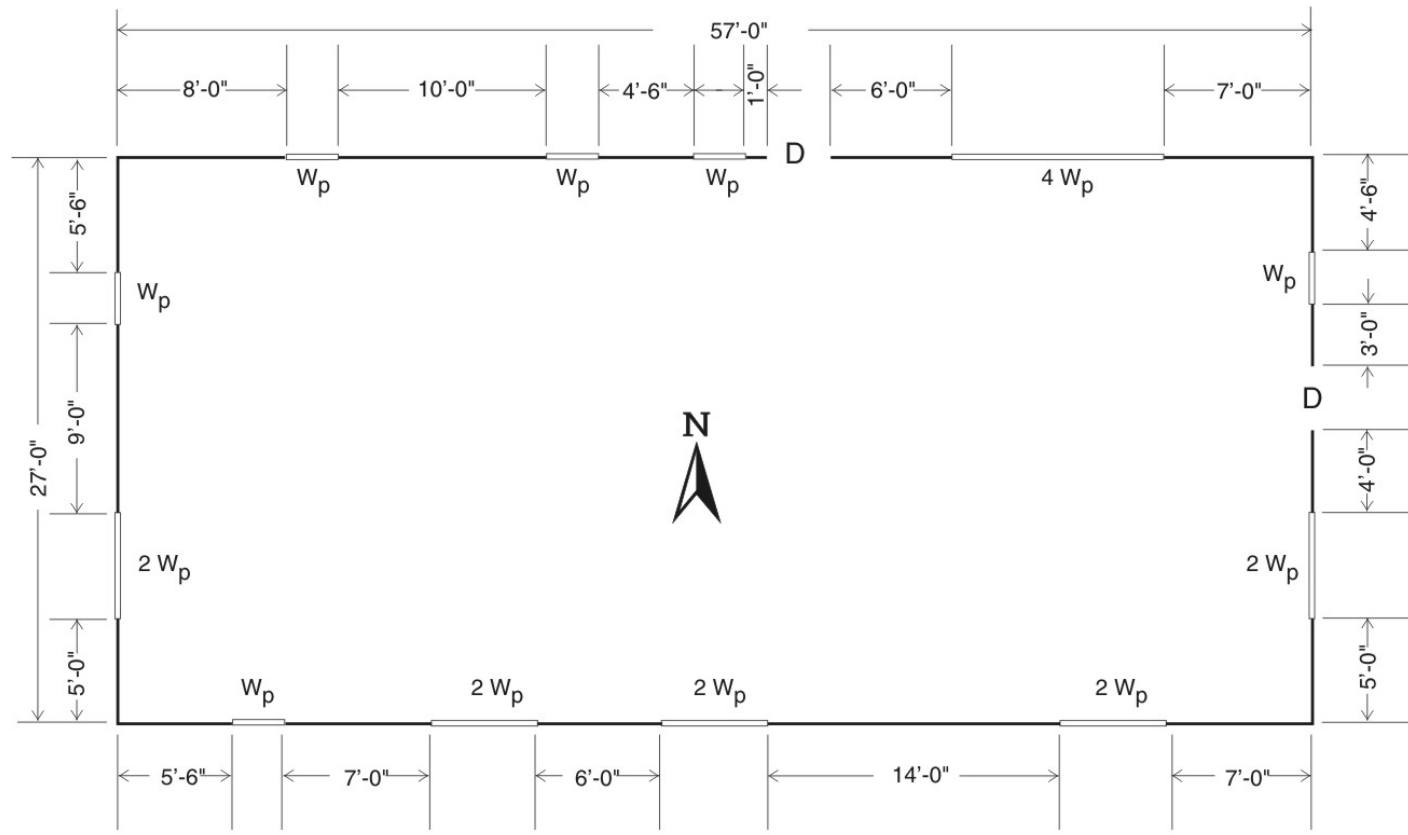

CD-RH06-A0327329

Plan

Legend:

#W_p:

W_p = window (2'6" wide × 6'6" high), see Figure 7-31

= number of windows along given length of exterior wall

D = solid-core wood door (3' wide × 6'8" high)

Note: Interior wall locations are same as for Case P100A.

Figure 7-35 Window locations—Case P150A.

TABLE 7-59 Building Thermal Summary—Case P150A

ELEMENT	AREA ft ²	R h·ft ² ·°F/Btu	U Btu/(h·ft ² ·°F)	UA Btu/(h·°F)	HEATCAP Btu/°F
(Note 1)		(Note 2)	(Note 2)	(Note 2)	(Note 3)
Exterior Walls (Note 4)	979	23.58	0.042	41.5	1656
North Windows (Note 5)	113.75	1.96	0.510	58.0	
East Windows (Note 5)	48.75	1.96	0.510	24.9	
West Windows (Note 5)	48.75	1.96	0.510	24.9	
South Windows (Note 5)	113.75	1.96	0.510	58.0	
Doors	40	3.04	0.329	13.2	62
Ceiling/Attic/Roof (Note 6)	1539	59.53	0.017	25.9	1850
Floor (Note 6)	1539	23.35	0.043	65.9	11131
Infiltration					
Colorado Springs, CO				118.2	
Interior Low Mass Walls	688				957
Interior High Mass Walls	336				6989
TOTAL BUILDING					22645
Excluding Infiltration				312.2	
Including Infiltration (Colorado Springs, CO)				430.3	

PASSIVE SOLAR DESIGN SUMMARY

Net south glass area ft ²	S.GL.A/ Floor A	Heatcap/ S.GL.A Btu/(°F·ft ²)	Mass A/ S.GL.A	LCR (Note 7) Btu/(day·°F·ft ²)
83	0.054	272.6	22.57	111.9

Note 1: Changes to Case P100A are highlighted by bold font. Windows have been removed from the south wall.

Note 2: Includes interior and exterior surface coefficients.

Note 3: Heat capacity includes building mass within the thermal envelope (e.g., insulation and insulation thickness of structural framing are included, exterior siding and roof/attic mass are excluded).

Note 4: Excludes area of doors. ASHRAE framed area fraction of 0.22 used for 2x6 24" O.C. construction.

Note 5: Window area and other properties are for glass and frame combined. North and south walls contain 7 window units each; east and west walls contain 3 window units each. These are the same window units as Case P100A (Figure 7-31).

Note 6: ASHRAE roof/ceiling framing area fraction of 0.1 used for both ceiling and floor.

Note 7: LCR is Load to Collector area Ratio, calculated from: ([Total building UA including infiltration] - [south glass UA]) × (24 h/day)/(south glass area).

TABLE 7-60 Component Surface Areas and Solar Fractions—Case P150A

ELEMENT (Note 1)	HEIGHT or LENGTH ft	WIDTH ft	MULTIPLIER	AREA ft ²	INSIDE SOLAR FRACTION
EXTERIOR SOUTH WALL					(Note 2)
Gross Wall	8.0	57.0	1.0	456.0	
Gross Window	6.5	2.5	7.0	113.8	
Window Frame Only			7.0	30.7	0.0039
Insulated L120A Wall (Note 3)				267.0	0.0343
Framed L120A Wall (Note 3)				75.3	0.0097
EXTERIOR NORTH WALL					
Gross Wall	8.0	57.0	1.0	456.0	
Door	6.67	3.0	1.0	20.0	0.0026
Gross Window	6.5	2.5	7.0	113.8	
Window Frame Only			7.0	30.7	0.0039
Insulated L120A Wall (Note 3)				251.4	0.0323
Framed L120A Wall (Note 3)				70.9	0.0091
EXTERIOR EAST WALL					
Gross Wall	8.0	27.0	1.0	216.0	
Door	6.67	3.0	1.0	20.0	0.0026
Gross Window	6.5	2.5	3.0	48.8	
Window Frame Only			3.0	13.2	0.0017
Insulated L120A Wall (Note 3)				114.9	0.0148
Framed L120A Wall (Note 3)				32.4	0.0042
EXTERIOR WEST WALL					
Gross Wall	8.0	27.0	1.0	216.0	
Gross Window	6.5	2.5	3.0	48.8	
Window Frame Only			3.0	13.2	0.0017
Insulated L120A Wall (Note 3)				130.5	0.0168
Framed L120A Wall (Note 3)				36.8	0.0047
FLOOR/CEILING					
Gross Floor/Ceiling	57.0	27.0	1.0	1539.0	
Insulated Floor/Ceiling (Note 4)				1385.1	0.1780
Framed Floor/Ceiling (Note 4)				153.9	0.0198
INTERIOR WALLS					
Gross Wall (Note 5)	8.0	128.0		1024.0	
Mass Wall (Note 5)	8.0	14.0	3.0	336.0	0.0432
Unframed Wall (Note 5)				619.2	0.0796
Framed Wall (Note 5)				68.8	0.0088

Note 1: Changes to Case P100A are highlighted with bold font.

Note 2: Solar energy transmitted through windows is assumed as distributed to interior opaque surfaces in proportion to their areas. Only the radiation not directly absorbed by lightweight furnishings (assumed to exist only for the purpose of calculating inside solar fraction) or not lost back out through windows is distributed to interior opaque surfaces.

Note 3: Insulated and framed exterior wall sections are defined in Figure 7-9 (Case L120A). ASHRAE framed area fraction of 0.22 is assumed for 2x6 24" O.C. construction.

Note 4: Insulated and framed floor and ceiling sections are defined in Figures 7-29 (Case P100A) and 7-10 (Case L120A) respectively. ASHRAE roof/ceiling framing area fraction of 0.1 applied to both ceiling and floor.

Note 5: Width is the length of interior walls from Figure 7-2 (Case L100A) and Figure 7-28 (Case P100A). Framed wall area is assumed to be 10% of gross wall area for 2x4 16" O.C. framing. Only one side of the wall is considered for listed area. This area is multiplied by 2 to determine solar fractions. Solar fractions shown are for just one side of the wall. Interior walls within the conditioned zone have been included for the purpose of modeling the effect of their mass. They are not intended to divide the conditioned zone into separately controlled zones.

[Informative note: Normative Section 8 is all new material. Underlining is not used here.]

8. CLASS II OUTPUT REQUIREMENTS

Enter all results into the appropriate standard output report (see Annex A2)

8.1 Tier-1 Tests. For the Tier-1 Tests, generate output for comparison to the example results as shown in Table 8-1. Sea-

sonal results shall be for heating and cooling seasons for the entire year or some other reasonable length as defined by the tool being tested. For software that designates heating and cooling seasons, enter Julian dates for first and last dates of the heating and cooling seasons designated by the software being tested where indicated in the accompanying file RESULTS7-2.XLS (see sheet "Sec7-2out"). Monthly example results and instructions for use of seasonal results are provided in informative Annex B20.

TABLE 8-1 HERS BESTEST Tier-1 Output Requirements

CASE	Annual (or seasonal) sensible heating load (10 ⁶ Btu/y) for listed climate	Annual (or seasonal) sensible cooling load (10 ⁶ Btu/y) for listed climate
L100A	CS	LV
L110A	CS	LV
L120A	CS	LV
L130A	CS	LV
L140A	CS	LV
L150A	CS	LV
L155A	CS	LV
L160A	CS	LV
L170A	CS	LV
L200A	CS	LV
L202A	CS	LV
L302A	CS	N/A
L304A	CS	N/A
L322A	CS	N/A
L324A	CS	N/A

CS = simulate the case for Colorad.TMY (Colorado Springs, Colorado)
 LV = simulate the case for Lasvega.TMY (Las Vegas, Nevada)
 N/A = not applicable, do not generate output

8.2 Tier-2 Tests. For the Tier 2 Tests, generate output for comparison to the example results as shown in Table 8-2. Seasonal results shall be for heating and cooling seasons for the entire year or some other reasonable length as defined by the tool being tested. For software that designates heating and cooling seasons, monthly example results and instructions for use of these results are provided in informative Annex B20.

Note that in Table 8-2 for cases P100A through P150A the climate data for generating cooling load outputs is Colorado.TMY. This is because the passive solar design described in Cases P100A and P105A, while appropriate for Colorado Springs, Colorado, is inappropriate for Las Vegas, Nevada.

TABLE 8-2 HERS BESTEST Tier 2 Output Requirements

CASE	Annual (or seasonal) sensible heating load (10⁶ Btu/y) for listed climate	Annual (or seasonal) sensible cooling load (10⁶ Btu/y) for listed climate
L165A	CS	LV
P100A	CS	CS
P105A	CS	CS
P110A	CS	CS
P140A	CS	CS
P150A	CS	CS

CS = simulate the case for Colorad.TMY
 LV = simulate the case for Lasvega.TMY

(This is a normative annex and is part of this standard.)

NORMATIVE ANNEX A1 WEATHER DATA

[Informative Note: Revise title and introduction of section A1.1 as shown]

A1.1 Weather Data for Building Thermal Envelope and Fabric Load Tests of Section 5.2. The full-year weather data (DRYCOLD.TMY) on the electronic media provided with this standard method of test shall be used for performing the tests called out in Section 5.2. Site and weather characteristics are summarized in Table A1-1. Details about TMY weather data file format are included in Section A1.5.

[Informative Note: Update section cross-references within A1.2 and A1.3 as shown]

A1.2 Weather Data for Space Cooling Equipment Performance Tests

A1.2.1 Analytical Verification Test Weather Data. The weather data listed in Table A1-2 shall be used as called out in Sections 5.3.1 and 5.3.2. These data files represent TMY and TMY2 format weather data files, respectively, with modifications so that the initial fundamental series of mechanical equipment tests may be very tightly controlled. The TMY-format data are three-month-long data files used in the original field trials of the test procedure; the TMY2-format data are year-long data files that may be more convenient for users. For the purposes of HVAC BESTEST, which uses a near-adiabatic building envelope, the TMY and TMY2 data sets are equivalent. (Note that there are small differences in solar radiation, wind speed, etc., that result in a sensible loads difference of 0.2%-0.3% in cases with low internal gains [i.e., E130, E140, E190, and E195]. This percentage load differ-

ence is less [0.01%-0.04%] for the other cases because they have higher internal gains. These TMY and TMY2 data are not equivalent for use with a non-near-adiabatic building envelope.)

Ambient dry-bulb and dew-point temperatures are constant in all the weather files; constant values of ambient dry-bulb temperature vary among the files according to the file name. Site and weather characteristics are summarized in Tables A1-3a and A1-3b for the TMY and TMY2 data files, respectively. Details about the TMY and TMY2 weather data file formats are included in Sections ~~A1.4 and A1.5~~ and A1.6, respectively.

A1.2.2 Comparative Test Weather Data. The full-year weather data file CE300.TM2 provided on the accompanying electronic media shall be used for performing the tests called out in Sections 5.3.3 and 5.3.4. Site and weather characteristics of the data file are summarized in Table A1-4. This data file represents TMY2 format weather data; details about TMY2 weather data file format are included in ~~Section A1.5~~ Section A1.6.

A1.3 Weather Data for Space Heating Equipment Performance Tests. Weather data listed in Table A1-5 shall be used as called out in section 5.4. These data are presented in WYEC2 format.¹⁰ See ~~Section A1.6~~ Section A1.7 for a detailed description of the WYEC2 format. Site characteristics are summarized in Table A1-6.

[Informative Note: Add new section A1.4 and new Tables A1-7, A1-8 and A1-9 as shown]

A1.4 Weather Data for Section 7 Tests. Full-year TMY weather data listed in Table A1-7 shall be used as called out in Section 7.2. Site and weather characteristics are summarized in Tables A1-8 and A1-9. Details about TMY weather data file format are included in Section A1.5.

TABLE A1-7 Weather Data for Section 7 Tests

<u>Data Files</u>	<u>Applicable Cases/Output</u>	<u>Sections</u>
<u>Colorad.TMY</u>	<u>Heating load results for all Tier 1 cases (L100A through L324A)</u>	<u>7.2.1, 7.2.2</u>
	<u>Heating load results for Tier 2 Case L165A</u>	<u>7.2.3.1</u>
	<u>Heating and cooling load results for Tier 2 cases P100A through P150A</u>	<u>7.2.3.2 through 7.2.3.6</u>
<u>Lasvega.TMY</u>	<u>Cooling load results for Tier 1 cases L100A through L202A</u>	<u>7.2.1, 7.2.2.1 through 7.2.2.10</u>
	<u>Cooling load results for Tier 2 Case L165A</u>	<u>7.2.3.1</u>

TABLE A1-8 Site and Weather Data Summary for Section 7 Tests Specifying Colorad. TMY (Note 1)

<u>Weather Type</u>	<u>Cold Clear Winters</u>
<u>Weather Format</u>	<u>Typical Meteorological Year (TMY)</u>
<u>Latitude</u>	<u>38.8° North</u>
<u>Longitude</u>	<u>104.7° West</u>
<u>Altitude</u>	<u>6145 ft</u>
<u>Time Zone</u>	<u>7</u>
<u>Ground Reflectivity</u>	<u>0.2</u>
<u>Site</u>	<u>flat, unobstructed, located exactly at weather station</u>
<u>Mean Annual Wind Speed</u>	<u>10.7 mph</u>
<u>Mean Annual Ambient Dry-Bulb Temperature</u>	<u>49.43°F</u>
<u>Mean Annual Daily Temperature Range</u>	<u>25.5°F</u>
<u>Minimum Annual Dry-Bulb Temperature</u>	<u>-9.9°F</u>
<u>Maximum Annual Dry-Bulb Temperature</u>	<u>93.9°F</u>
<u>Maximum Annual Wind Speed</u>	<u>36.9 mph</u>
<u>Heating Degree Days (Base 65°F)</u>	<u>6031.0°F·days (Note 2)</u>
<u>Cooling Degree Days (Base 65°F)</u>	<u>489.5°F·days (Note 2)</u>
<u>Mean Annual Dew Point Temperature</u>	<u>27.9°F</u>
<u>Mean Annual Humidity Ratio</u>	<u>0.0047</u>
<u>Global Horizontal Solar Radiation Annual Total</u>	<u>584.33 kBtu/(ft²·y)</u>
<u>Direct Normal Solar Radiation Annual Total</u>	<u>759.67 kBtu/(ft²·y)</u>
<u>Direct Horizontal Solar Radiation</u>	<u>430.27 kBtu/(ft²·y)</u>
<u>Diffuse Horizontal Solar Radiation</u>	<u>154.07 kBtu/(ft²·y)</u>

Note 1: Unless otherwise noted, values are SERIRES/SUNCODE weather outputs.

Note 2: From DOE2.1E weather processor summary.

TABLE A1-9 Site and Weather Data Summary for Section 7 Tests Specifying Lasvega.TMY (Note 1)

<u>Weather Type</u>	<u>Hot Dry Summers</u>
<u>Weather Format</u>	<u>Typical Meteorological Year (TMY)</u>
<u>Latitude</u>	<u>36.1° North</u>
<u>Longitude</u>	<u>115.2° West</u>
<u>Altitude</u>	<u>2178 ft</u>
<u>Time Zone</u>	<u>8</u>
<u>Ground Reflectivity</u>	<u>0.2</u>
<u>Site</u>	<u>flat, unobstructed, located exactly at weather station</u>
<u>Mean Annual Wind Speed</u>	<u>9.6 mph</u>
<u>Mean Annual Ambient Dry-Bulb Temperature</u>	<u>66.69°F</u>
<u>Mean Annual Daily Temperature Range</u>	<u>23.6°F</u>
<u>Minimum Annual Dry-Bulb Temperature</u>	<u>23.0°F</u>
<u>Maximum Annual Dry-Bulb Temperature</u>	<u>113.0°F</u>
<u>Maximum Annual Wind Speed</u>	<u>35.8 mph</u>
<u>Heating Degree Days (Base 65°F)</u>	<u>2415.0°F·days (Note 2)</u>
<u>Cooling Degree Days (Base 65°F)</u>	<u>3025.0°F·days (Note 2)</u>
<u>Mean Annual Dew Point Temperature</u>	<u>28.1°F</u>
<u>Mean Annual Humidity Ratio</u>	<u>0.0040</u>
<u>Global Horizontal Solar Radiation Annual Total</u>	<u>687.38 kBtu/(ft²·y)</u>
<u>Direct Normal Solar Radiation Annual Total</u>	<u>872.62 kBtu/(ft²·y)</u>
<u>Direct Horizontal Solar Radiation</u>	<u>528.86 kBtu/(ft²·y)</u>
<u>Diffuse Horizontal Solar Radiation</u>	<u>158.52 kBtu/(ft²·y)</u>

Note 1: Unless otherwise noted, values are SERIRES/SUNCODE weather outputs.

Note 2: From DOE2.1E weather processor summary.

[Informative Note: Renumber sections A1.4 through A1.6 (as A1.5 through A1.7) and Tables A1-7 through A1-10 (as A1-10 through A1-13) as shown. Only text shown for these sections to indicate where changes occur; no other changes to text or tables for these sections other than that shown.]

A1.4 A1.5 TMY Weather Data Format. For those programs that do not have Typical Meteorological Year (TMY) weather processors, TMY weather data file format is provided in Table A1-7 A1-10.

A1.5 A1.6 TMY2 Weather Data Format.

A1.5.1 A1.6.1 File Header. The first record of each file is the file header that describes the station. The file header contains the WBAN number, city, state, time zone, latitude, longitude, and elevation. The field positions and definitions of these header elements are given in Table A1-8 A1-11, along with sample FORTRAN and C formats for reading the header. A sample of a file header and data for January 1 is shown in Figure A1-1.

A1.5.2 A1.6.2 Hourly Records. Following the file header, 8,760 hourly data records provide one year of solar radiation, illuminance, and meteorological data, along with their source and uncertainty flags. Table A1-9 A1-12 provides field positions, element definitions, and sample FORTRAN and C formats for reading the hourly records.

A1.6 A1.7 WYEC2 Weather Data Format. For those programs that do not have Weather Year for Energy Calculations 2 (WYEC2) weather processors, WYEC2 weather data file format is described below.

Weather files in WYEC2 format consist of 8760 identical fixed-format records (8,784 records for leap years), one for each hour of each day of the year. Each record is 116 characters (plus 2 for CR/LF) in length and is organized according to Table A1-10 A1-13.

[Informative Note: Renumber headers for Tables A1-7 through A1-10 (as A1-10 through A1-13) as shown. Only header text shown; no other changes to tables other than to headers as shown.]

TABLE A1-7 A1-10 Typical Meteorological Year Data Format

[informative note: change to header occurs in 4 places (pp. 71-74 of 140-2007)]

TABLE A1-8 A1-11 Header Elements in the TMY2 Format (For First Record of Each File)

TABLE A1-9 A1-12 Data Elements in the TMY2 Format (For All Except the First Record)

[informative note: change to header occurs in 2 places (pp. 77-78 of 140-2007)]

TABLE A1-10 A1-13 Data Elements in the WYEC2 Format

(This is a normative annex and is part of this standard.)

NORMATIVE ANNEX A2 STANDARD OUTPUT REPORTS

[Informative note: Revise Annex A2 as shown; changes update 140-2007 Addendum a (by the Data Format Subcommittee). Only text shown is that needed to indicate changes; other Annex A2 text remains as is.]

The standard output reports consist of ~~five~~six forms provided with the electronic media accompanying this standard:

- Output Results for Cases of Section 5.2 (Sec5-2out.XLS, spreadsheet file)
- Output Results for Cases of Sections 5.3.1 and 5.3.2 (Sec5-3Aout.XLS, spreadsheet file)
- Output Results for Cases of Sections 5.3.3 and 5.3.4 (Sec5-3Bout.XLS, spreadsheet file)
- Output Results for Cases of Section 5.4 (Sec5-4out.XLS, spreadsheet file)
- Output Results for Cases of Section 7.2 (sheet 'Sec7-2out' within RESULTS7-2.XLS spreadsheet file)
- Modeling Notes (S140outNotes.TXT, text file reprinted as Attachment A2.5)

For entering output results into Sec5-2out.XLS, Sec5-3Aout.XLS, Sec5-3Bout.XLS, ~~and Sec5-4out.XLS, and sheet 'Sec7-2out' within RESULTS7-2.XLS,~~ follow the instructions provided at the top of the appropriate electronic spreadsheet file or designated sheet within the spreadsheet file. These instructions are reprinted as Attachments A2.1, A2.2, A2.3, and A2.4 respectively, within this section; instructions for 'Sec7-2out' within RESULTS7-2.XLS are not reprinted here.

For entering modeling notes into S140outNotes.TXT, use the format of the examples given in Attachments A2.6 within this section. Note: The report author shall create one modeling notes TXT document for each section of tests, e.g.,

- S140outNotes_5-2.TXT for the Class I building thermal envelope and fabric load tests of Section 5.2
- S140outNotes_5-3A.TXT for the Class I space cooling equipment performance analytical verification tests of Sections 5.3.1 and 5.3.2
- S140outNotes_5-3B.TXT for the Class I space cooling equipment performance comparative tests of Sections 5.3.3 and 5.3.4
- S140outNotes_5-4.TXT for the Class I space heating equipment performance tests of Section 5.4-
- S140outNotes_7-2.TXT for the Class II test procedures of Section 7.2.

(This annex is not part of the standard. It is merely informative and does not contain requirements necessary for conformance to the standard. It has not been processed according to the ANSI requirements for a standard and may contain material that has not been subject to public review or a consensus process. Unresolved objectors on informative material are not offered the right to appeal at ASHRAE or ANSI.)

INFORMATIVE ANNEX B1 TABULAR SUMMARY OF TEST CASES

[Informative Note: Add Table B1-5, revise introductory text, and revise headers for Tables B1-1a and B1-1b as shown. Only the text necessary for identifying changes is shown.]

Tables B1-1a and B1-1b include a tabular summary of the Class I building thermal envelope and fabric load test cases described in Section 5.2, in SI units only. Tables B1-2a and B1-2b include a tabular summary of the Space-Cooling Equipment Performance Analytical Verification Test Cases described in Sections 5.3.1 and 5.3.2, in SI and I-P units, respectively. Table B1-3 includes a tabular summary of the Space-Cooling Equipment Performance Comparative Test Cases described in Sections 5.3.3 and 5.3.4, in SI units only.

Table B1-4 summarizes the Space-Heating Equipment test cases described in Section 5.4, in SI units only. Table B1-5 summarizes the Class II building thermal envelope and fabric load tests described in Section 7.2, in I-P units only.

Nomenclature

Abbreviations and symbols used in Tables B1-1a, B1-1b, B1-2a, B1-2b, B1-3, and B1-4 are listed below. Abbreviations used for Table B1-5 are listed with that table.

**TABLE B1-1a ~~Standard 140~~Section 5.2 Case Descriptions,
Low Mass In-Depth**

**TABLE B1-1b ~~Standard 140~~Section 5.2 Case Descriptions,
Basic and In-Depth Cases**

TABLE B1-5 Section 7.2 Case Descriptions

CASE#/ Test Tier	SUB- FLOOR	INFIL. (ACH)	R-VALUE (h·ft ² ·°F/Btu)			WINDOW DATA			COMMENTS (Note 1)
			WALLS. (Note 2)	CEILING	FLOOR	TYPE	AREA (ft ²) (Note 3)	ORIENT	
L100A/ T1	RF	0.67	12, 21	14	SATB	Gross: 270 Net: 197	AVG DIST	NO	Base building. Simple construction with typical glazing and insulation. Represents average of US building stock.
L110A/ T1	RF	1.5	12, 21	14	SATB	Gross: 270 Net: 197	AVG DIST	NO	Tests infiltration.
L120A/ T1	RF	0.67	24, 60	14	SATB	Gross: 270 Net: 197	AVG DIST	NO	Tests wall and ceiling R-value together.
L130A/ T1	RF	0.67	12, 21	14	DLEW	Gross: 270 Net: 197	AVG DIST	NO	Tests glazing physical properties together.
L140A/ T1	RF	0.67	12, 21	14	None	0	N/A	NO	Tests glazing area.
L150A/ T1	RF	0.67	12, 21	14	SATB	Gross: 270 Net: 197	1.0 S	NO	Tests glazing orientation.
L155A/ T1	RF	0.67	12, 21	14	SATB	Gross: 270 Net: 197	1.0 S	H	Tests South opaque overhang.
L160A/ T1	RF	0.67	12, 21	14	SATB	Gross: 270 Net: 197	0.5E,0.5W	NO	Tests E/W glazing orientation.
L165A/ T2	RF	0.67	12, 21	14	SATB	Gross: 270 Net: 197	0.5E,0.5W	HV	Tests E/W shading.
L170A/ T1	RF	0.67	12, 21	14	SATB	Gross: 270 Net: 197	AVG DIST	NO	Internal loads = 0. Tests internal loads.
L200A/ T1	RF	1.5	5, 12	4	SATB	Gross: 270 Net: 197	AVG DIST	NO	Lumped sensitivity low efficiency. Tests HERS ability to cover wide range of construction
L202A/ T1	RF	1.5	5, 12	4	SATB	Gross: 270 Net: 197	AVG DIST	NO	Exterior Solar Absorptance = 0.2. Tests low solar absorptance.
L302A/ T1	SLAB	0.67	12, 21	UNINS	SATB	Gross: 270 Net: 197	AVG DIST	NO	Tests ground coupling with uninsulated slab using ASHRAE perimeter method.
L304A/ T1	SLAB	0.67	12, 21	EDGE INS	SATB	Gross: 270 Net: 197	AVG DIST	NO	Tests perimeter insulated slab using ASHRAE perimeter method.
L322A/ T1	BASE- MENT	0.67	12, 21 (Note 4)	UNINS	SATB	Gross: 270 Net: 197	AVG DIST	NO	Tests ground coupling with uninsulated full basement using ASHRAE method.
L324A/ T1	BASE- MENT	0.67	12, 21 (Note 4)	UNINS	SATB	Gross: 270 Net: 197	AVG DIST	NO	Tests ground coupling with insulated full basement using ASHRAE method.

TABLE B1-5 Section 7.2 Case Descriptions (continued)

CASE#/ Test Tier	SUB- FLOOR	INFIL. (ACH)	R-VALUE (h·ft ² ·°F/Btu)			WINDOW DATA			COMMENTS (Note 1)
			WALLS. (Note 2)	CEILING	FLOOR	TYPE	AREA (ft ²) (Note 3)	ORIENT	
P100A/ T2	RF	0.67	24, 60	23	DW	Gross: 325 Net: 237	1.0 S	NO	High mass passive solar construction. Base building for P-series cases.
P105A/ T2	RF	0.67	24, 60	23	DW	Gross: 325 Net: 237	1.0 S	H	Tests South opaque overhang.
P110A/ T2	RF	0.67	24, 60	23	DW	Gross: 325 Net: 237	1.0 S	NO	Low mass version of passive base case. Tests mass effect.
P140A/ T2	RF	0.67	24, 60	23	None	0	N/A	NO	Tests glazing area.
P150A/ T2	RF	0.67	24, 60	23	DW	Gross: 325 Net: 237	AVG DIST	NO	Tests glazing orientation.

ABBREVIATIONS

Test Tier: T1 = Tier 1, T2 = Tier 2

SUBFLOOR = construction below main floor, RF = raised floor, SLAB = slab on grade, BASEMENT = full basement.

INFIL. (ACH) = Infiltration (Air Changes per Hour)

R-VALUE, FLOOR: UNINS = slab or basement coupled to ground, EDGE INS = 4 ft deep perimeter slab insulation.

WINDOW DATA: SATB = single pane, clear glass, aluminum frame with thermal break; DLEW = double pane, low-e glass, wood frame, insulated spacer;

DW = double pane, clear glass, wood frame, metal spacer.

ORIENT = Orientation; AVG DIST = window area distributed over walls in proportion to total exterior wall area.

N/A = not applicable; 1.0 S = all windows on south wall; 0.5E, 0.5W = 50% of window area on east wall and 50% of window area on west wall.

SHADE = window shading device; H = horizontal shade (overhang); HV = horizontal and vertical shading (overhang and fins).

ASHRAE = American Society of Heating, Refrigerating, and Air-Conditioning Engineers, Atlanta, GA.

NOTES

Note 1: Changes to Case L100A are highlighted with bold font.

Note 2: These are composite R-values including all materials, films, and the presence of the attic for ceiling R-value; see Section 7.2 for more detail.

Note 3: Gross area is the total window area including the frame; net area is the area of just the glass portion of the window.

Note 4: Basement below-grade wall R-values including the ground are: L322A = R-8, L324A = R-19.

(This annex is not part of the standard. It is merely informative and does not contain requirements necessary for conformance to the standard. It has not been processed according to the ANSI requirements for a standard and may contain material that has not been subject to public review or a consensus process. Unresolved objectors on informative material are not offered the right to appeal at ASHRAE or ANSI.)

INFORMATIVE ANNEX B2 ABOUT TYPICAL METEOROLOGICAL YEAR (TMY) WEATHER DATA

[Informative Note: Revise text as shown. Only text necessary for identifying changes is shown.]

TMY data are used in Standard 140, Section 5.2 for the following reasons:

- ~~The~~ For Section 5.2, the original research that is the foundation of Standard 140, IEA BESTEST, was performed by the National Renewable Energy Laboratory in collaboration with the International Energy Agency.¹⁷ The underlying research used in this standard began in 1990 and was completed in 1993. At that time TMY data represented the state-of-the-art ~~regarding~~ for hourly weather data.
- During the process of converting the original NREL/IEA work into a Standard Method of Test, SPC 140 considered changing the weather data file and format. The problems with this were as follows:
 - Some parts of the test specification are based on the specific TMY data file provided with Standard 140. For example, the convective portion of annual average exterior combined surface coefficients – provided for those programs that do not calculate exterior convection hourly – are related to the average annual wind speed from the original weather data file. This means that some inputs in the test specification would need to be changed.
 - The example results of informative Annex B8 would not be consistent with user-generated results if new weather data were used—unless the test cases were rerun for all the programs shown. For many users of Standard 140, the evaluation of results will be facilitated by being able to compare the results for their program with the example results presented in Annex B8, which requires using consistent testing methods and weather data.

The original research for Section 7.2, HERS BESTEST, was performed by NREL in collaboration with the U.S. HERS Council Technical Committee, B-1, B-10. The underlying research began in 1993 and was completed in 1995. At that time TMY data represented the state-of-the-art for hourly weather data. (TMY2 data were just becoming available toward the end of the project, but the work was too far along to switch weather data files, which would have required adjusting test specifications.)

~~For these reasons, SPC 140 decided to keep the original TMY weather data and the detailed documentation of the TMY weather data format. For Sections 5.3.1 and 5.3.2, either TMY-format data or TMY2-format data may be used as described in Annex A1, Section A1.2.1.~~

(This annex is not part of the standard. It is merely informative and does not contain requirements necessary for conformance to the standard. It has not been processed according to the ANSI requirements for a standard and may contain material that has not been subject to public review or a consensus process. Unresolved objectors on informative material are not offered the right to appeal at ASHRAE or ANSI.)

INFORMATIVE ANNEX B3 INFILTRATION AND FAN ADJUSTMENTS FOR ALTITUDE

[Note: for revisions to existing material, deleted text is marked with ~~strikethrough~~ and new text with underline. Only text needed to identify changes is shown.]

B3.1 General Equation. The decline in air density with altitude may be expressed according to the following exponential curve fit:

$$\rho_{\text{air,u}} = \rho_{\text{air,0}} \times e^{(a)(\text{elev})} \quad (\text{B3-1})$$

B3.2 Adjustments for Section 5.2 Test Cases

where:

- $\rho_{\text{air,u}}$ = air density at specified elevation
- $\rho_{\text{air,0}}$ = air density at sea level
- e = inverse Ln
- a = $-1.219755 \times 10^{-4}/\text{m}$
- elev = elevation in meters (m)

[Note: keep current remaining text here without changes; add new B3.3 below current text.]

B3.3 Adjustments for Section 7.2 Test Cases. For HERS BESTEST^{B-1} parameters of Equation B3-1 are:

- $\rho_{\text{air,u}}$ = Air density at specified elevation
- $\rho_{\text{air,0}}$ = Air density at sea level = 0.075 lb/ft³
(approximate value)
- e = Inverse Ln
- a = $-3.71781196 \times 10^{-5}/\text{ft}$
- elev = elevation in feet (ft)

This results in:

- Air density at 6145 ft = 0.05968 lb/ft³
- Air density at 2178 ft = 0.06917 lb/ft³

If the software being tested does not allow variation of air density, the specified infiltration rate is adjusted as:

$$\text{Corrected Infiltration Rate for 6145 ft altitude} = (\text{Specified Rate}) \times (0.05968/0.075)$$

$$\text{Corrected Infiltration Rate for 2178 ft altitude} = (\text{Specified Rate}) \times (0.06917/0.075)$$

Table B3-1 summarizes the appropriate variation of infiltration rates from HERS BESTEST specified values for the base case (Case L100A) and cases where infiltration rates or building air volume have varied. These corrections are only to be used with software that does not automatically account for local variations in air density.

Table B3-1 also includes values of equivalent thermal conductance due to infiltration (UA_{inf}) corresponding to altitude-corrected air densities where:

$$UA_{inf} = \rho_{air,u} \times V \times c_p$$

and where:

V = volumetric air flow rate (ft³/h) converted from values in Table B3-1

c_p = specific heat of air = 0.240 Btu/(lb_m·°F)

TABLE B3-1. HERS BESTEST Infiltration Rate Adjustment for Altitude

	<u>Air Volume</u>				
	<u>(Note 1)</u>	<u>Altitude</u>			<u>UA_{inf}</u>
	<u>ft³</u>	<u>ft</u>	<u>ACH</u>	<u>CFM</u>	<u>Btu/(h·°F)</u>
<u>CASE L100A</u>	<u>12312</u>				
<u>HERS w/ automatic altitude adjustment</u>			<u>0.67</u>	<u>137.5</u>	
<u>HERS w/ site fixed at sea level</u>					
<u>Colorado Springs, CO</u>		<u>6145</u>	<u>0.533</u>	<u>109.4</u>	<u>118.2</u>
<u>Las Vegas, NV</u>		<u>2178</u>	<u>0.618</u>	<u>126.8</u>	<u>136.9</u>
<u>CASE L110A</u>	<u>12312</u>				
<u>HERS w/ automatic altitude adjustment</u>			<u>1.50</u>	<u>307.8</u>	
<u>HERS w/ site fixed at sea level</u>					
<u>Colorado Springs, CO</u>		<u>6145</u>	<u>1.194</u>	<u>244.9</u>	<u>264.5</u>
<u>Las Vegas, NV</u>		<u>2178</u>	<u>1.383</u>	<u>283.9</u>	<u>306.6</u>
<u>CASE L322A (Note 2)</u>	<u>24624</u>				
<u>HERS w/ automatic altitude adjustment</u>			<u>0.335</u>	<u>137.5</u>	
<u>HERS w/ site fixed at sea level</u>					
<u>Colorado Springs, CO</u>		<u>6145</u>	<u>0.267</u>	<u>109.4</u>	<u>118.2</u>
<u>ATTIC (ALL CASES)</u>	<u>3463</u>				
<u>HERS w/ automatic altitude adjustment</u>			<u>2.40</u>	<u>138.5</u>	
<u>HERS w/ site fixed at sea level</u>					
<u>Colorado Springs, CO</u>		<u>6145</u>	<u>1.910</u>	<u>110.2</u>	
<u>Las Vegas, NV</u>		<u>2178</u>	<u>2.213</u>	<u>127.7</u>	

Note 1: Air volumes listed for specific cases only include those of the conditioned zone(s). Unconditioned attic air volume is listed separately.

Note 2: Only used if basement model combines main floor and basement zones into a single aggregate zone. Otherwise, Case L322A main floor zone uses the Case L100A infiltration rate and the basement zone infiltration rate is 0 ach.

(This annex is not part of the standard. It is merely informative and does not contain requirements necessary for conformance to the standard. It has not been processed according to the ANSI requirements for a standard and may contain material that has not been subject to public review or a consensus process. Unresolved objectors on informative material are not offered the right to appeal at ASHRAE or ANSI.)

**INFORMATIVE ANNEX B4
EXTERIOR COMBINED RADIATIVE
AND CONVECTIVE SURFACE COEFFICIENTS**

[Note: for revisions to existing material, deleted text is marked with ~~strikethrough~~ and new text with underline.]

B4.1 General Equation. ASHRAE and some simulation programs (e.g., BLAST 3.0 Level 193, using its option for simple outside surface conductance) calculate the exterior combined radiative and convective surface coefficient as a second order polynomial in wind speed of the form:

$$h = a_1 + a_2V + a_3V^2, \quad (B4-1)$$

where the units of h are W/m²K, and the “a” coefficients are dependent on the surface texture. ~~Assuming a surface texture of brick or rough plaster, and a mean annual wind~~

~~speed of 4.02 m/s, then the information in Table B4-1 is applicable¹⁹.~~

B4.2 Exterior Surface Coefficients for Section 5.2 Test Cases. Assuming a surface texture of brick or rough plaster, and a mean annual wind speed of 4.02 m/s, then the information in Table B4-1a is applicable¹⁹.

For cases where the exterior infrared emittance = 0.9, the exterior combined surface coefficient for all walls and roofs will be 29.3 W/m²K, and the exterior combined surface coefficient for glass and high conductance walls/opaque windows will be 21.0 W/m²K.

For cases where the exterior infrared emittance = 0.1, the exterior combined surface coefficient for all walls and roofs will be 25.2 W/m²K, and the exterior combined surface coefficient for high conductance walls/opaque windows will be 16.9 W/m²K.

For convenience of input, the exterior combined radiative and convective surface coefficient for the transparent window and the opaque window are assumed to be the same, even though the hemispherical infrared emittance of ordinary uncoated window glass is usually 0.84. This is equivalent to assuming that the emittance of the glass is 0.9.

Convective and radiative portions of these coefficients are disaggregated in informative Annex B5.

Table B4-1a Polynomial Coefficients for Describing Exterior Surface Coefficient as a Function of Wind Speed (SI Units)

Material	a ₁	a ₂	a ₃
Stucco	11.58	5.894	0.0
Brick/rough plaster	12.49	4.065	0.028
Concrete	10.79	4.192	0.0
Clear pine	8.23	4.0	-0.057
Smooth plaster	10.22	3.1	0.0
Glass	8.23	3.33	-0.036

B4.3 Exterior Surface Coefficients for Section 7.2 Test Cases. For HERS BESTEST, the “a” coefficients that apply for Equation B4-1 (using I-P units) are listed in Table B4-1b.

Assuming a surface texture of brick or rough plaster, and a mean annual wind speed of 10.7 mph (9.304 knots), then:

Exterior Combined Surface Coefficient for All Walls and Roofs = 5.748 Btu/(h·ft²·°F)

For programs requiring a method for disaggregation of infrared and convective surface coefficients from combined surface coefficients, see informative Annex B5.

TABLE B4-1b Polynomial Coefficients for Describing Exterior Surface Coefficient as a Function of Wind Speed (I-P Units)

<u>Material</u>	<u>a₁</u>	<u>a₂</u>	<u>a₃</u>
<u>Stucco</u>	<u>2.04</u>	<u>0.535</u>	<u>0.0</u>
<u>Brick/Rough Plaster</u>	<u>2.20</u>	<u>0.369</u>	<u>0.001329</u>
<u>Concrete</u>	<u>1.90</u>	<u>0.380</u>	<u>0.0</u>
<u>Clear Pine</u>	<u>1.45</u>	<u>0.363</u>	<u>-0.002658</u>
<u>Smooth Plaster</u>	<u>1.80</u>	<u>0.281</u>	<u>0.0</u>
<u>Glass</u>	<u>1.45</u>	<u>0.302</u>	<u>-0.001661</u>

(This annex is not part of the standard. It is merely informative and does not contain requirements necessary for conformance to the standard. It has not been processed according to the ANSI requirements for a standard and may contain material that has not been subject to public review or a consensus process. Unresolved objectors on informative material are not offered the right to appeal at ASHRAE or ANSI.)

INFORMATIVE ANNEX B5 INFRARED PORTION OF FILM COEFFICIENTS

[Note: for revisions to existing material, deleted text is marked with ~~strikethrough~~ and new text with underline.]

Nomenclature

BESTEST	<u>Building Energy Simulation Test</u>
DLEW	<u>Double pane, low-e window with wood frame and insulated spacer</u>
DW	<u>Double pane, clear window with wood frame and metal spacer</u>
Hemis	<u>Hemispherical</u>
HERS	<u>Home Energy Rating System</u>
IEA	<u>International Energy Agency</u>
Low-E	<u>Low emissivity</u>
SATB	<u>Single pane window with aluminum frame and thermal break</u>

B5.1 General Equation.

The infrared portion of film coefficients is based on the linearized gray-body radiation equation²⁰:

$$h_i = 4\varepsilon\sigma T^3, \quad (\text{B5-1})$$

B5.2 Tabulation for Section 5.2 Test Cases.

where:

ε	= infrared emittance
σ	= $5.67 \times 10^{-8} \text{ W/m}^2\text{K}^4$ (Stefan-Boltzmann constant)
T	= average temperature of surrounding surfaces [assumed 10°C (283 K) for outside, 20°C (293 K) for inside]
K	= Kelvin (absolute 0 = -273.16°C)
h_i	= infrared radiation portion of surface coefficient
h_c	= convective portion of surface coefficient
h_s	= total combined interior surface coefficient
h_o	= total combined outside surface coefficient

For convenience of input, the interior combined radiative and convective surface coefficient for the opaque window and the transparent window are assumed the same, even though the hemispherical infrared emittance of ordinary uncoated window glass is usually 0.84. This is equivalent to assuming that the emittance of the glass is 0.9. Table B5-1 shows convective and infrared radiative portions of film coefficients for various surface types of IEA BESTEST.^{B-11}

TABLE B5-1 Disaggregation of Film Coefficients Versus Surface Infrared Emittance for Various Surface Types Related to Section 5.2 Tests (SI Units)

Very Smooth Surface Outside ^a (T = 10°C) (283 K)	$\varepsilon = 0.9$	$\varepsilon = 0.84$	$\varepsilon = 0.1$
h_i , W/(m ² ·K)	4.63	4.32	0.51
h_o , W/(m ² ·K)	21	20.69	16.88
h_c , W/(m ² ·K) = $h_o - h_i$	16.37	16.37	16.37
Inside Surface (T = 20°C) (293 K)			
h_i , W/(m ² ·K)	5.13	4.79	0.57
h_s , W/(m ² ·K)	8.29	7.95	3.73
h_c , W/(m ² ·K) = $h_s - h_i$	3.16	3.16	3.16
Brick/Rough Plaster Outside ^a (T = 10°C) (283 K)			
h_i , W/(m ² ·K)	4.63		0.51
h_o , W/(m ² ·K)	29.3		25.18
h_c , W/(m ² ·K) = $h_o - h_i$	24.67		24.67

^a Based on a mean annual wind speed of 4.02 m/s for outside surfaces.

B5.3 Tabulation for Section 7.2 Test Cases.

For HERS BESTEST, the parameters of Equation B5-1 are:

- $\underline{\epsilon}$ = Infrared emissivity
- $\underline{\sigma}$ = $0.1718 \times 10^{-8} \text{ Btu}/(\text{h}\cdot\text{ft}^2\cdot\text{R}^4)$ (Stefan/Boltzmann constant)
- T = Average temperature of surrounding surfaces (assumed 50°F [510°R] for outside, 68°F [528°R] for inside)
- R = Rankine (absolute zero = 0°R = -459.67°F)
- h_i = Infrared radiation portion of surface coefficient.

- h_c = Convective portion of surface coefficient
- h_s = Total combined interior surface coefficient
- h_o = Total combined outside surface coefficient.

Tables B5-2 and B5-3 show convective and infrared radiative portions of film coefficients for the various orientations and surfaces of HERS BESTEST. In Table B5-2, combined exterior surface coefficients are evaluated using the algorithm of informative Annex B4; combined interior surface coefficients are based on ASHRAE data (see *ASHRAE 1993 Handbook—Fundamentals*, p. 22.1)^{B-7}. In Table B5-3, combined interior and exterior surface coefficients are based on the output of WINDOW 4.1.^{B-6}

Other nomenclature used for Tables B5-2 and B5-3 are:

TABLE B5-2 Disaggregated Film Coefficients for Opaque Surfaces for Section 7.2 Tests (I-P Units)

Inside Horizontal Surface (T= 68°F) (528°R) ($\underline{\epsilon}=0.9$)	
h_i , Btu/(h·ft ² ·°F)	0.908
h_s , Btu/(h·ft ² ·°F)	1.307
$h_{c,s}$, Btu/(h·ft ² ·°F) = $h_s - h_i$	0.399
Inside Vertical Surface (T= 68°F) (528°R) ($\underline{\epsilon}=0.9$)	
h_i , Btu/(h·ft ² ·°F)	0.908
h_s , Btu/(h·ft ² ·°F)	1.460
$h_{c,s}$, Btu/(h·ft ² ·°F) = $h_s - h_i$	0.552
Inside Sloped (18.4°) Surface (T= 68°F) (528°R) ($\underline{\epsilon}=0.9$)	
h_i , Btu/(h·ft ² ·°F)	0.908
h_s , Btu/(h·ft ² ·°F)	1.330
$h_{c,s}$, Btu/(h·ft ² ·°F) = $h_s - h_i$	0.422
Brick/Rough Plaster, Outside (T= 50°F) (510°R) (windspeed = 10.7 mph) ($\underline{\epsilon}=0.9$)	
h_i , Btu/(h·ft ² ·°F)	0.819
h_o , Btu/(h·ft ² ·°F)	5.748
$h_{c,o}$, Btu/(h·ft ² ·°F) = $h_o - h_i$	4.929
Brick/Rough Plaster, Outside (T= 50°F) (510°R) (windspeed = 0.0 mph) ($\underline{\epsilon}=0.9$)	
h_i , Btu/(h·ft ² ·°F)	0.819
h_o , Btu/(h·ft ² ·°F)	2.200
$h_{c,o}$, Btu/(h·ft ² ·°F) = $h_o - h_i$	1.381

TABLE B5-3 Disaggregated Film Coefficients for Windows and Window Frames for Section 7.2 Tests (I-P Units)

Very Smooth Surface Outside (T = 50°F) (510°R) (windspeed = 10.7 mph) ($\epsilon = 0.84$)	All Types of Windows		
h_i , Btu/(h·ft ² ·°F)	0.764		
h_o , Btu/(h·ft ² ·°F)	4.256		
h_{cs} , Btu/(h·ft ² ·°F) = $h_o - h_i$	3.492		
Inside Vertical Surface (T=68°F) (528°R) ($\epsilon = 0.84$)	SATB	DLEW	DW
h_i , Btu/(h·ft ² ·°F)	0.848	0.848	0.848
h_s , Btu/(h·ft ² ·°F)	1.460	1.333	1.397
h_{cs} , Btu/(h·ft ² ·°F) = $h_s - h_i$	0.612	0.485	0.549

SATB = Single pane, clear glass, aluminum frame with thermal break
DLEW = Double pane, low-e glass, wood frame with insulated spacer
DW = Double pane, clear glass, wood frame with metal spacer

(This annex is not part of the standard. It is merely informative and does not contain requirements necessary for conformance to the standard. It has not been processed according to the ANSI requirements for a standard and may contain material that has not been subject to public review or a consensus process. Unresolved objectors on informative material are not offered the right to appeal at ASHRAE or ANSI.)

INFORMATIVE ANNEX B7 DETAILED CALCULATION OF SOLAR FRACTIONS

[Informative Note: Revise current B7.1 and B7.2 section titles as noted (deleted text is marked with ~~strickethrough~~ and new text with underline); text within those current sections is unchanged. Add new Section B7.2.]

B7.1 Solar Fraction Approximation Algorithm for Section 5.2 Test Cases

~~B7.2~~ B7.1.1 A Note about Selected Results for Interior Solar Absorptance (α) = 0.9

B7.2 Solar Fraction Approximation Algorithm for Section 7.2 Test Cases. This section describes the method used to determine "solar lost" for Section 7.2 tests. The assumptions here are useful for the calculation of solar lost, but would result in different inside solar fractions for various opaque surfaces than the area weighting shown in Section 7.2 tables that contain solar fractions (e.g., Table 7-3). A spreadsheet tabulation of the calculation process is provided in Table B7-4. Note that interior walls have been excluded to simplify the calculation of solar lost.

Some equations described below differ from those of Section B7.1. For single-pane glazing, the solar lost approximations are calculated from:

$$SF_n = B1_n + B2_n + B3_n + BR_n$$

where:

n = a particular surface

SF = total solar fraction

B1 describes the first "bounce" of incident shortwave radiation assuming all of it initially hits the floor.

$$B1_{\text{floor}} = \alpha$$

$$B1_{\text{all other}} = 0$$

$$\alpha = \text{interior shortwave absorptance of opaque surfaces (all interior surfaces have the same absorptance except for the window which is denoted as } \alpha_w \text{).}$$

B2 describes the second "bounce" such that shortwave radiation diffusely reflected by the floor is distributed over other surfaces in proportion to their view-factor-absorptance product.

$$B2_{\text{floor-floor}} = 0$$

$$B2_{\text{floor-other opaque}} = (1 - \alpha)(FF_i)(\alpha)$$

$$B2_{\text{floor-window lost}} = (1 - \alpha)(FF_i)\{1 - [\rho_w + (N)(\alpha_w)]\}$$

$$B2_{\text{floor-window absorbed}} = (1 - \alpha)(FF_i)(N)(\alpha_w)$$

where:

FF are view factors from Figures B7-1 and B7-2, and accompanying equations for those figures given in Section B7.1.

i = particular surface which the floor "sees." View factors for windows are based on the view factor for the wall where the windows are located, multiplied by the fraction of the area of that wall occupied by the windows. View factors for walls with windows are adjusted similarly. To simplify calculation of solar lost, all windows are assumed located on the south wall (as in Case L150A).

ρ_w = reflectance for specific glazing, hemispherically integrated (diffuse radiation)

α_w = absorptance for specific glazing, hemispherically integrated (diffuse radiation)

N = inward conducted fraction of cavity reflected absorbed solar radiation. For single-pane glass, N is the ratio of the exterior film coefficient R-value to the total air-air center of glass R-value (for single-pane windows, this is the sum of the interior and exterior film coefficient R-values).

B3 describes the third bounce such that the remaining nonabsorbed shortwave radiation is distributed over each surface in proportion to its area-absorptance product. In this part and the final part of the calculation below, solar radiative exchange between opaque surfaces can be aggregated as shown in Table B7-4.

$$B3_{\text{opaque-opaque}} = [1 - \alpha - \sum(B2_n)](A_n/A_{\text{total}})(\alpha)$$

$$B3_{\text{opaque-window lost}} = [1 - \alpha - \sum(B2_n)](A_n/A_{\text{total}}) \{1 - [\rho_w + (N)(\alpha_w)]\}$$

$$B3_{\text{opaque-window absorbed}} = [1 - \alpha - \sum(B2_n)](A_n/A_{\text{total}})(N)(\alpha_w)$$

where:

$$A_n = \text{area of surface } n$$

$$A_{\text{total}} = \text{total area of all surfaces}$$

BR describes the distribution of all remaining bounces based on distribution fractions from calculations for B3_n above.

$$BR_n = [1 - \alpha - \sum(B2_n) - \sum(B3_n)] [B3_n / \sum(B3_n)]$$

For double-pane glazing, the solar lost calculation is the same as for single-pane glazing, except for the following differences.

$$B2_{\text{floor-window lost}} = (1 - \alpha)(FF_i) [1 - (\rho_w + N_i \alpha_i + N_o \alpha_o)]$$

$$B2_{\text{floor-window absorbed}} = (1 - \alpha)(FF_i)(N_i \alpha_i + N_o \alpha_o)$$

$$B3_{\text{opaque-window lost}} = [1 - \alpha - \sum(B2_n)](A_n/A_{\text{total}}) [1 - (\rho_w + N_i \alpha_i + N_o \alpha_o)]$$

$$B3_{\text{opaque-window absorbed}} = [1 - \alpha - \sum(B2_n)](A_n/A_{\text{total}}) (N_i \alpha_i + N_o \alpha_o)$$

where:

α_i = inner pane absorptance for specific glazing, hemispherically integrated (diffuse radiation).

N_i = inward conducted fraction of cavity reflected absorbed solar radiation for inner pane.

α_o = outer pane absorptance for specific glazing, hemispherically integrated (diffuse radiation).

N_o = inward conducted fraction of cavity reflected absorbed solar radiation for outer pane.

For double-pane glazing, N_i and N_o are the ratio of total R-value of the components on the exterior side of the pane in question to the total air-air center-of-glass R-value of the double-pane unit (including air gap between panes and interior and exterior film coefficients).

TABLE B7-4 Calculations of Solar Lost (Cavity Albedo) for Section 7.2 Tests

PROPERTIES	L100A		
Case	or L150A	L130A	P100A
alpha, walls	0.6	0.6	0.6
FF floor, n/s wall	0.09	0.09	0.09
FF floor, e/w wall	0.06	0.06	0.06
FF floor, ceiling	0.70	0.70	0.70
N.i	0.26	0.82	0.63
N.o		0.06	0.12
hemis inner pane alpha	0.098	0.041	0.076
hemis outer pane alpha		0.235	0.108
hemispherical reflectance	0.136	0.391	0.205
FRACTION OF INCIDENT RADIATION ABSORBED			
1ST BOUNCE (B1)			
Floor	0.6000	0.6000	0.6000
2ND BOUNCE (B2)			
S. Window out	0.0131	0.0088	0.0138
S. Window in	0.0004	0.0007	0.0011
S. Wall	0.0123	0.0123	0.0080
N. Wall	0.0216	0.0216	0.0216
E. Wall	0.0144	0.0144	0.0144
W. Wall	0.0144	0.0144	0.0144
Ceiling	0.1680	0.1680	0.1680
Total	0.2441	0.2401	0.2413
3RD BOUNCE (B3)			
Opaque-opaque	0.0894	0.0916	0.0901
S. Window out	0.0058	0.0040	0.0063
S. Window in	0.0002	0.0003	0.0005
Total	0.0954	0.0960	0.0969
REMAINING BOUNCES (BR)			
Opaque-opaque	0.0567	0.0610	0.0575
S. Window out	0.0037	0.0027	0.0040
S. Window in	0.0001	0.0002	0.0003
Total	0.0605	0.0639	0.0618
Total Solar Fraction	1.0000	1.0000	1.0000
Total Solar Lost	0.0226	0.0154	0.0240

ABBREVIATIONS:

alpha = interior shortwave absorptance; FF_{a,b} = Form factor from a to b;

N = fraction of window absorbed solar radiation conducted inward;

hemis = hemispherically integrated.

ASSUMPTIONS:

All solar radiation assumed to initially hit the floor, all south window configuration, interior walls ignored for this calculation, "solar to air" = 0.

[Informative note: the only change to Annex B8 is to Annex title as shown below]

[Informative note: Section B10.5 is new informative material appended to informative Annex B10]

**INFORMATIVE ANNEX B8
EXAMPLE RESULTS FOR BUILDING THERMAL
ENVELOPE AND FABRIC LOAD TESTS_
OF SECTION 5.2**

(This annex is not part of the standard. It is merely informative and does not contain requirements necessary for conformance to the standard. It has not been processed according to the ANSI requirements for a standard and may contain material that has not been subject to public review or a consensus process. Unresolved objectors on informative material are not offered the right to appeal at ASHRAE or ANSI.)

**INFORMATIVE ANNEX B10
INSTRUCTIONS FOR WORKING WITH RESULTS
SPREADSHEETS PROVIDED WITH THE STANDARD**

B10.5 Documentation for RESULTS7-2.XLS (also see RESULTS7-2.DOC). This file contains Tier 1 and Tier 2 test case example simulation results presented in informational Annex B20. These data are provided for the convenience of users who wish to plot or tabulate their results along with the example results. Enter data within the sheet with tab label 'Sec7-2out' (leftmost tab), within appropriate yellow highlighted cells. Entered data automatically flows to sheet with tab label "PlotData" and to all of the plots (see contents of sheets, listed below). Example results shown in charts are automatically adjusted for seasonal comparison, for heating and cooling seasons identified by the tested software entered in sheet 'Sec7-2out'.

Contents of Sheets:

<u>Sheet</u>	<u>Description</u>
<u>'Sec7-2out'</u>	<u>Standard output report, results template for inputting new results for the program being tested; data entered here automatically flows to the 'PlotData' sheet (see below).</u>
<u>'Tables B20'</u>	<u>Tier 1 and Tier 2 example results summary tables (See Annex B20 for contents information). Results for the program being tested do not flow to this sheet.</u>
<u>'Fig-B20-1 T1 Htg1' through 'Fig-B20-12 T2 dClg'</u>	<u>Tier 1 and Tier 2 example and tested program results figures (See Annex B20 for contents information). Results for the program being tested automatically flow to these figures from the 'PlotData' sheet (see below). Example results shown here are automatically adjusted for seasonal comparison, for heating and cooling seasons identified by the tested software entered in sheet 'Sec7-2out'.</u>
<u>'BLAST-HtgRes'</u>	<u>BLAST 3.0 monthly and total heating loads tables, including seasonal load calculation.</u>
<u>'BLAST-ClgRes'</u>	<u>BLAST 3.0 monthly and total sensible cooling loads tables, including seasonal load calculation.</u>
<u>'DOE-HtgRes'</u>	<u>DOE2.1E monthly and total heating loads tables, including seasonal load calculation.</u>
<u>'DOE-ClgRes'</u>	<u>DOE2.1E monthly and total sensible cooling loads tables, including seasonal load calculation.</u>
<u>'SRES-HtgRes'</u>	<u>SERIRES/SUNCODE 5.7 monthly and total heating loads tables, including seasonal load calculation.</u>
<u>'SRES-ClgRes'</u>	<u>SERIRES/SUNCODE 5.7 monthly and total sensible cooling loads tables, including seasonal load calculation.</u>
<u>'PlotData'</u>	<u>Tier 1 and Tier 2 example results formatted for use as source data for charts. Seasonal results for the program being tested automatically appear in the rows labeled with the name of the tested program entered in sheet 'Sec7-2out'.</u>
<u>'Season Coeff'</u>	<u>Heating and cooling season coefficients, automatically calculated based on user entry in sheet 'Sec7-2out', cells C28, D28, C30 and C31.</u>

[Informative note: Change title of Annex B11 as shown below]

INFORMATIVE ANNEX B11 PRODUCTION OF EXAMPLE RESULTS FOR BUILDING THERMAL ENVELOPE AND FABRIC LOAD TESTS OF SECTION 5.2

[Informative note: Change cross-referencing within Section B11.3 as shown; only text necessary for indicating changes is shown.]

B11.3 Hourly Time Convention

Details of differences in modeling methods utilized by various software are given in Part II of *IEA BESTEST*.¹⁶ That reference does not discuss how the specified time convention is modeled by various simulation software. For Standard 140, the time convention for the input specification and hourly outputs is standard time, while the time convention for Typical Meteorological Year (TMY) weather data is solar time (see Annex A1, ~~Section A1.4~~ Section A1.5, for discussion of the difference between solar time and standard time). The time convention is therefore most correctly modeled by software that rebins TMY data into hourly data based on local standard time. A tabulation of how the time convention was modeled by some of the software used to generate the example results given in informative Annex B8 is noted in Table B11-3.

Since software being tested by Standard 140 may not be rebinning TMY data, it is important to understand the potential differences in Standard 140 results that can be generated by applying a time convention different from that specified in Section 5.1.1. In Standard 140 such differences are minimized, and are primarily related to the equation of time (see Annex A1, ~~Section A1.4~~ Section A1.5), because the building site has been located within 0.1° longitude of the standard meridian. For this reason Standard 140 does not provide a good test for the ability to calculate solar incidence angles for longitudes far away from the standard meridian.

[Informative note: Change title of informative Annex B16 as shown below]

INFORMATIVE ANNEX B16 ANALYTICAL AND QUASI-ANALYTICAL SOLUTION RESULTS AND EXAMPLE SIMULATION RESULTS FOR HVAC EQUIPMENT PERFORMANCE TESTS OF SECTIONS 5.3 AND 5.4

[Informative note: Change title of informative Annex B17 as shown below]

INFORMATIVE ANNEX B17 PRODUCTION OF QUASI-ANALYTICAL SOLUTION RESULTS AND EXAMPLE SIMULATION RESULTS FOR HVAC EQUIPMENT PERFORMANCE TESTS OF SECTIONS 5.3 AND 5.4

[Informative note: Change cross-referencing within Section B17.1.2.2 as shown; only text necessary for indicating changes is shown.]

B17.1.2.2 Disagreements Related to TMY2 Data Time Convention. According to the TMY2 weather data documentation included in Annex A1, ~~Section A1.5~~ Section A1.6, solar radiation data represent

(This annex is not part of the standard. It is merely informative and does not contain requirements necessary for conformance to the standard. It has not been processed according to the ANSI requirements for a standard and may contain material that has not been subject to public review or a consensus process. Unresolved objectors on informative material are not offered the right to appeal at ASHRAE or ANSI.)

[Informative note: Informative Annex B18 is all new material. Underlining is not used to show additions to the current standard in this annex.]

INFORMATIVE ANNEX B18 ALTERNATIVE SECTION 7 GROUND COUPLING ANALYSIS CASE DESCRIPTIONS FOR DEVELOPING ADDITIONAL EXAMPLE RESULTS FOR CASES L302B, L304B, L322B, AND L324B

The results for two types of ground coupling models are included in the results of informative Annex B20 to effectively widen the range of example results for cases that include ground coupling analysis. This was done in case a residential modeling tool is using a more sophisticated algorithm than the application of ASHRAE steady-state heat transfer coefficients.

For the more detailed simulations of ground coupling in Cases L302B, L304B, L322B and L324B, the following case-by-case discussion describes material properties for modeling thermal mass of portions of the building envelope in thermal contact with the ground. While this more detailed method is not verified, it does serve to incorporate the effects of mass and solar radiation incident on soil directly into the simulations used to develop example results, thus reducing loads versus the various steady-state ASHRAE methods.

B18.1 Soil Modeling and Solar Effects. In the tables that follow, soil thicknesses may be regarded as curved path lengths for one-dimensional heat conduction between a concrete surface/adjacent soil boundary and a soil/ambient air boundary. Thus, soil is modeled as a large amount of mass in contact with ambient air. Soil conductivity is based on the 9.6 Btu-in/(h-ft²·°F) cited in *ASHRAE 1993 Fundamentals*.^{B-7}

Solar effects on soil are also important (especially regarding shorter conduction path lengths encountered with a slab-on-grade or the upper portion of a below-grade wall). Soil adjacent to a house is assumed as shaded by the house on average roughly half the time the sun is present. Exterior solar absorptance of the soil surface is assumed as 0.6. Exterior infrared emittance of soil is assumed as 0.9. The adjacent-soil-to-house-wall view factors are small so that infrared radiative exchange is assumed to occur only between soil and sky.

B18.2 Case L302B Uninsulated Slab on Grade. This case is exactly as Case L302A except that Table B18-1 is used in place of Table 7-36.

The soil thickness in Table B18-1 is based on the ASHRAE perimeter method^{B-7} for a metal stud wall (normalized for 1539 ft² floor area) less listed R-values of surface coefficients and the concrete slab and assuming the listed soil conductivity.

TABLE B18-1 Material Descriptions, Slab on Grade Floor—Case L302B

FLOOR, SLAB ON GRADE, UNINSULATED WITH GROUND MASS						
ELEMENT (inside to outside)	Thickness in.	R h·ft ² ·°F/Btu	U Btu/(h·ft ² ·°F)	k Btu/(h·ft·°F)	DENSITY lb/ft ³	Cp Btu/(lb·°F)
Int Surf Coef (Note 1)		0.765	1.307			
Carpet with fibrous pad		2.080	0.481			
Concrete slab	4.0	0.320	3.125	1.0417	140.0	0.20
Soil (Note 2)	58.3	6.070	0.165	0.8000	94.0	0.19
Ext Surf Coef		0.174	5.748			
Total air-air		9.409	0.106			

Note 1: Average of ASHRAE heating and cooling coefficients.

Note 2: Soil thickness based on ASHRAE perimeter method for a metal stud wall (normalized for 1539 ft² floor area) less R-values of surface coefficients and concrete slab assuming the listed soil conductivity. The resulting soil thickness can be thought of as an average curved heat flow path through the soil to ambient air. As a simplification, the layer of sand typically below the concrete slab and the poured foundation wall is assumed to have the same material properties as soil.

B18.3 Case L304B Slab-on-Grade with Perimeter Insulation. This case is exactly as Case L304A, except that Table B18-2 replaces Table 7-38.

The perimeter insulation R-value of Table B18-2 is based on the ASHRAE perimeter method for a metal stud wall with

R-5.4 perimeter insulation from edge to footer normalized for 1539 ft² floor area, less the R-values of the listed surface coefficients, concrete slab and soil layers.

TABLE B18-2 Material Descriptions, Slab on Grade Floor—Case L304B

FLOOR, SLAB ON GRADE, PERIMETER INSULATION WITH GROUND MASS						
(Note 1)	Thickness	R	U	k	DENSITY	Cp
ELEMENT (inside to outside)	in.	h·ft ² ·°F/Btu	Btu/(h·ft ² ·°F)	Btu/(h·ft·°F)	lb/ft ³	Btu/(lb·°F)
Int Surf Coef (Note 2)		0.765	1.307			
Carpet with fibrous pad		2.080	0.481			
Concrete slab	4.0	0.320	3.125	1.0417	140.0	0.20
Soil (Note 3)	29.1	3.035	0.330	0.8000	94.0	0.19
Perimeter insulation (Note 4)		9.327	0.107			
Soil (Note 3)	29.1	3.035	0.330	0.8000	94.0	0.19
Ext Surf Coef		0.174	5.748			
Total air-air		18.736	0.053			

Note 1: Changes to Case L302B are highlighted with bold font.

Note 2: Average of ASHRAE heating and cooling coefficients.

Note 3: Total soil path length from Case L302B divided by two.

Note 4: Perimeter insulation R-value based on ASHRAE perimeter method for metal stud wall with R-5.4 perimeter insulation from edge to footer in Colorado Springs normalized for floor area, less R-values of surface coefficients, concrete slab, and soil layers.

B18.4 Case L322B Uninsulated Conditioned Basement.

This case is **exactly as Case L322A, except** that Table B18-3 replaces Table 7-42 and just the below-grade concrete wall description of Table 7-41.

For below-grade walls, the associated soil thicknesses are taken directly from *ASHRAE 1993 Fundamentals* (Table 14, p. 25.11).^{B-7} Note that the listed below-grade soils are for paral-

lel conduction paths, each representing 1 foot of wall height, except for the deepest increment, which represents 7 inches of wall height.

For the below grade slab floor, soil thickness is based on *ASHRAE 1993 Fundamentals* (Table 15, p. 25.11)^{B-7} less R-values of surface coefficients and concrete slab, and multiplied by the listed soil conductivity.

TABLE B18-3 Material Descriptions, Basement Below Grade Wall and Slab Floor—Case 322B

BASEMENT BELOW GRADE WALL (inside to outside) WITH GROUND MASS						
ELEMENT	Thickness in.	R h·ft ² ·°F/Btu	U Btu/(h·ft ² ·°F)	k Btu/(h·ft·°F)	DENSITY lb/ft ³	Cp Btu/(lb·°F)
BELOW GRADE CONCRETE WALL						
Int Surf Coef		0.685	1.460			
Poured concrete	6.0	0.480	2.083	1.0417	140.0	0.20
Below grade soil is in parallel paths for listed increments of depth. (Note 1)						
Below grade soil 0'-1' depth	8.16	0.850	1.176	0.8000	94.0	0.19
Below grade soil 1'-2' depth	27.2	2.838	0.352	0.8000	94.0	0.19
Below grade soil 2'-3' depth	46.6	4.850	0.206	0.8000	94.0	0.19
Below grade soil 3'-4' depth	66.2	6.900	0.145	0.8000	94.0	0.19
Below grade soil 4'-5' depth	84.6	8.813	0.113	0.8000	94.0	0.19
Below grade soil 5'-6' depth	103.8	10.813	0.092	0.8000	94.0	0.19
Below grade soil 6'-6'7" depth	123.4	12.850	0.078	0.8000	94.0	0.19
Ext Surf Coef		0.174	5.748			
Total air - air (Note 2)		5.481	0.182			
BASEMENT BELOW SLAB FLOOR (inside to outside) WITH GROUND MASS						
Int Surf Coef		0.765	1.307			
Poured concrete	4.0	0.320	3.125	1.0417	140.0	0.20
Below grade soil below slab (Note 3)	380.1	39.592	0.025	0.8000	94.0	0.19
Ext Surf Coef		0.174	5.748			
Total air-air (Note 4)		40.851	0.0245			

Note 1: Listed thickness is the ASHRAE (1993 Handbook of Fundamentals, Table 14, p.25.11) (Reference B-7), conduction path length. Also each layer is only 1' high except for the deepest layer which is only 7" high.

Note 2: Although ASHRAE's soil conductivity was applied, overall U-value calculated by summing parallel heat flow through each increment of soil depth comes out 7% higher than the value of Table 7-41 which was obtained using just the ASHRAE steady-state heat transfer coefficients.

Note 3: Soil thickness based on ASHRAE 1993 Fundamentals (Reference B-7), Table 15, p.25.11 (Heat Loss through Basement Floors) less R-values of surface coefficients and concrete slab assuming the listed soil conductivity. The resulting soil thickness can be thought of as an average curved heat flow path through the soil to ambient air. As a simplification, the layer of sand typically below the concrete slab is assumed to have the same material properties as soil.

Note 4: This is the overall heat loss interpolated from ASHRAE 1993 Fundamentals, Table 15, p. 25.11. (Reference B-7).

B18.5 Case L324B Interior Insulated Conditioned Basement. This case is exactly as Case L324A, except that Table B18-4 replaces just the below-grade concrete wall description of Table 7-46.

TABLE B18-4 Material Descriptions, Basement Below Grade Wall—Case L324B

BASEMENT BELOW GRADE WALL (inside to outside) WITH GROUND MASS						
(Note 1)	Thickness	R	U	k	DENSITY	Cp
ELEMENT	in.	h·ft ² ·°F/Btu	Btu/(h·ft ² ·°F)	Btu/(h·ft·°F)	lb/ft ³	Btu/(lb·°F)
Int Surf Coef		0.685	1.460			
Plasterboard	0.5	0.450	2.222	0.0926	50.0	0.26
Fiberglass batt (Note 2)	3.5	11.000	0.091	0.0265	0.6	0.20
Frame 2x4, 16" on centers (Note 3)	3.5	4.373	0.229	0.0667	32.0	0.33
Batt/frame composite (Note 4)		9.989	0.100			
Poured concrete	6.0	0.480	2.083	1.0417	140.0	0.20
Below grade soil is in parallel paths for listed increments of depth. (Note 5)						
Below grade soil 0'-1' depth	8.16	0.850	1.176	0.8000	94.0	0.19
Below grade soil 1'-2' depth	27.2	2.838	0.352	0.8000	94.0	0.19
Below grade soil 2'-3' depth	46.6	4.850	0.206	0.8000	94.0	0.19
Below grade soil 3'-4' depth	66.2	6.900	0.145	0.8000	94.0	0.19
Below grade soil 4'-5' depth	84.6	8.813	0.113	0.8000	94.0	0.19
Below grade soil 5'-6' depth	103.8	10.813	0.092	0.8000	94.0	0.19
Below grade soil 6'-6'7" depth	123.4	12.850	0.078	0.8000	94.0	0.19
Ext Surf Coef		0.174	5.748			
Total air - air (Note 6)		15.920	0.063			

Note 1: Changes to Case L322B are highlighted with bold font.

Note 2: Insulated section only, 90% insulated area section.

Note 3: Framed section only, 10% framed area section.

Note 4: Due to the complexity of this below grade wall construction, the insulated framed basement wall was modeled using this combined resistance in the example results simulations. The R-value shown is the total air-air composite section below grade basement wall R-value given in Table 7-46 less the Table 7-46 R-values for interior film coefficient, plasterboard, and "wall and soil".

Note 5: Listed thickness is the ASHRAE (1993 Handbook of Fundamentals [Reference B-7], Table 14, p.25.11) conduction path length. Also each layer is only 1' high except for the deepest layer which is only 7" high.

Note 6: The overall U-value calculated by summing parallel heat flow through each increment of soil depth comes out 2% higher than the value of Table 7-46.

(This annex is not part of the standard. It is merely informative and does not contain requirements necessary for conformance to the standard. It has not been processed according to the ANSI requirements for a standard and may contain material that has not been subject to public review or a consensus process. Unresolved objectors on informative material are not offered the right to appeal at ASHRAE or ANSI.)

[Informative note: Informative Annex B19 is all new material. Underlining is not used to show additions to the current standard in this annex.]

INFORMATIVE ANNEX B19 DISTRIBUTION OF SOLAR RADIATION IN THE SECTION 7 PASSIVE SOLAR BASE CASE (P100A)

Solar energy transmitted through windows is distributed in the following manner.

Solar lost due to cavity albedo and solar directly absorbed by air (lightweight furnishings) are attributed to total (direct

plus diffuse) radiation in proportion to the fractions of direct and diffuse solar radiation transmitted through windows. Direct and diffuse transmitted fractions for south windows were calculated using SERIRES/SUNCODE^{B-5} and Denver TMY weather data.

The portion of direct-beam radiation not absorbed by lightweight furnishings or lost from cavity albedo is assumed to initially hit only the massive surfaces (floor and interior brick walls), and is distributed among these surfaces according to their areas. Direct-beam radiation that is reflected by the massive surfaces is assumed to be diffusely reflected and is distributed among all interior surfaces in proportion to their areas.

Transmitted diffuse radiation not absorbed by lightweight furnishings or lost from cavity albedo is distributed among all interior surfaces in proportion to their areas.

Resulting interior solar distribution fractions are shown in Table B19-1.

TABLE B19-1 Interior Surface Distribution of Solar Radiation for Case P100A

PROPERTIES/ASSUMPTIONS			
alpha, walls	0.6		
Solar to Air	0.175		
Solar Lost	0.0240	(Note 1)	
direct beam frac.	0.7097	(Note 2)	
diffuse frac.	0.2903	(Note 2)	
direct beam floor depth (ft)	14	(Note 3)	
direct beam to floor	0.543	(Note 4)	
direct beam to masswall	0.457	(Note 4)	
floor area frac	0.2469	(Note 5)	
mass wall area frac	0.1078	(Note 5)	
	Relative	Absolute	
	Fractions	Fractions	
	(Note 6)	(Note 7)	
FRACTION OF TRANSMITTED DIRECT BEAM RADIATION ABSORBED			
Floor	0.2609	0.1852	(Note 8)
Interior Mass Wall	0.2197	0.1559	(Note 8)
Remaining reflected	0.3204	0.2274	
FRACTION OF DIFFUSELY REFLECTED BEAM RADIATION ABSORBED			
Floor	0.2469	0.0561	
Interior Mass Wall	0.1078	0.0245	
Remaining Opaque Surfs.	0.6453	0.1467	
FRACTION OF TRANSMITTED DIFFUSE RADIATION ABSORBED			
Floor	0.1978	0.0574	
Interior Mass Wall	0.0864	0.0251	
Remaining Opaque Surfs.	0.5169	0.1500	
TOTAL FRACTIONS			
Solar to Air		0.1750	
Solar Lost		0.0240	
Floor		0.2987	
Interior Mass Wall		0.2055	
Remaining Opaque Surfs.		0.2968	
Total		1.0000	

Note 1: From Annex B7, Section B7.2.

Note 2: From SUNCODE south window annual transmitted solar radiation, based on Denver TMY weather data.

Note 3: This is the location depth for the mass interior walls.

Note 4: Fraction of initially transmitted direct beam radiation incident on named surface after subtracting out solar-to-air and solar lost.

Note 5: Used for diffuse radiation distribution, based on full floor area.

Note 6: Fraction of the specific type of radiation noted below (e.g., direct beam radiation). Transmitted radiation relative fractions assume Solar Lost and Solar to Air noted above.

Note 7: Fraction of total direct plus diffuse transmitted radiation.

Note 8: Fraction of "first bounce" absorbed by named surface. Based on:

$$1 - (\text{solar to air}) - (\text{solar lost}) \times (\text{direct beam fraction to named surface}) \times (\text{alpha walls}).$$

(This annex is not part of the standard. It is merely informative and does not contain requirements necessary for conformance to the standard. It has not been processed according to the ANSI requirements for a standard and may contain material that has not been subject to public review or a consensus process. Unresolved objectors on informative material are not offered the right to appeal at ASHRAE or ANSI.)

INFORMATIVE ANNEX B20 EXAMPLE RESULTS FOR SECTION 7 TEST PROCEDURES

[Informative note: Informative Annex B20 is all new material. Underlining is not used to show additions to the current standard in this annex.]

The example results from three detailed building energy simulation programs for the test cases of Section 7.2 are presented in the accompanying file RESULTS7-2.XLS in tabular and graphic form, as described below. These results can be used for a comparison with the software being tested. Alternatively, a user can run a number of different programs through the Section 7.2 test cases and draw comparisons from those results independently or in conjunction with the results listed here.

The building energy simulation computer programs used to generate example results are described in informative Annex B21. These computer programs have been subjected to a number of analytical verification, empirical validation, and comparative testing studies. However, there is no such thing as a completely validated building energy simulation computer program. All building models are simplifications of reality. The philosophy here is to generate a range of results from several programs that are generally accepted as representing the state-of-the-art in whole building energy simulation programs. Regarding the presented results, to the extent possible input errors or differences have been eliminated. Thus, for a given case the range of differences between results presented in the informational Annex B20 represents algorithmic differences among these computer programs for the comparative building thermal fabric tests of Section 7.2. For any given case, a tested program may fall outside this range without necessarily being incorrect. However, it is worthwhile to investigate the source of significant differences, as the collective experience of the authors of this Standard is that such differences often indicate problems with the software or its usage, including, but not limited to:

- (a) user input error, where the user misinterpreted or mis-entered one or more program inputs;
- (b) problem with a particular algorithm in the program;
- (c) one or more program algorithms used outside their intended range.

Also for any given case, a program that yields values in the middle of the range established by the example results should not be perceived as better or worse than a program that yields values at the borders of the range.

For the convenience to users who wish to plot or tabulate their results along with the example results, an electronic version of the example results has been included with the file RESULTS7-2.XLS on the accompanying electronic media. Documentation regarding RESULTS7-2.XLS is included in RESULTS7-2.DOC; a summary print out is included in informative Annex B10, Section B10.5.

For generating these results, along with using consistent modeling methods, the simulations were conducted using the most detailed modeling methods allowed by the software, within the constraints of the test specification. For a summary of how example results were developed, see informative Annex B21. For more information about the example results, see *HERS BESTEST*.^{B-10}

B20.1 Results Overview. Tier 1 and Tier 2 example results are included in the figures and tables of Section B20.4. These results include tables and graphs of annual heating and cooling loads, and tables of monthly heating and cooling loads. Example results shown in charts are automatically adjusted for seasonal comparison, for heating and cooling seasons identified by the tested software. Additional "delta" tables and graphs show the differences between annual loads (sensitivity to variations) for each case relative to an appropriate base case.

In the example results, the following convention identifies the climate corresponding to a result:

- Cases ending in "AC" (e.g., L100AC) are heating load results for Colorad.TMY weather data
- Cases ending in "AL" (e.g., L100AL) are sensible cooling load results for Lasvega.TMY weather data

Sensitivity (or "Delta") results are listed using two case numbers separated by a minus sign; e.g., "L120AC-L100AC" is the difference between Case L120A (Section 7.2.2.2) and Case L100A (Section 7.2.1).

Because example results for slab-on-grade ground coupling include two sets of results generated using Colorad.TMY weather data (see Annex B21, Section B21.1), the following labeling convention applies to Cases L302 and L304:

- Cases ending in "BC" (e.g., L302BC) are additional outputs using more detailed ground coupling methods
- Use of the "AB" suffix in figures designates the combined results of specific "AC" and "BC" outputs (e.g., L302AB includes all L302AC and L302BC outputs).

Example results for basement ground coupling include four sets of results generated using Colorad.TMY weather data. These additional results were required to cover all modeling approaches resulting from two possible ground coupling models and two possible zoning models. The following labeling convention applies to Cases L322 and L324:

- Cases ending in "A1" (e.g., L322A1) use a simplified method (see Section 7.2.2.12) for modeling ground coupling with the entire building modeled as a single zone.

- Cases ending in "A2" (e.g., L322A2) use a simplified method (see Section 7.2.2.12) for modeling ground coupling with the main floor and basement modeled as separate zones.
- Cases ending in "B1" (e.g., L322B1) use more detailed ground coupling methods (see informative Annex B18, Section B18.4) with the entire building modeled as a single zone.
- Cases ending in "B2" (e.g., L322B2) use more detailed ground coupling methods (see informative Annex B18, Section B18.4) with the main floor and basement modeled as separate zones.
- Use of the "AB" suffix in figures designates the combined results of specific "A1," "A2," "B1" and "B2" outputs (e.g., L322AB includes the L322A1, L322A2, L322B1 and L322B2 outputs).

Because there are three example simulation programs, there are a total of 12 example outputs for each basement case.

B20.2 Comparing with Programs that Designate Heating and Cooling Seasons. Tables and charts of example monthly heating and cooling load results are provided for comparing residential modeling tools that designate heating and cooling seasons. Within RESULTS7-2.XLS, example results shown in charts are automatically adjusted for seasonal comparison, for heating and cooling seasons identified by the tested software. The automatic adjustment simply sums the appropriate example monthly load results for the given heating or cooling season. For comparing heating or cooling seasons, or both, beginning/ending during mid-month, the automatic adjustment linearly interpolates the monthly example results for given months as appropriate. "Delta" results are calculated automatically for the example results and test program results by taking the differences of the seasonal sum of results (sums per above). Automated calculations may be tracked within RESULTS7-2.XLS by beginning with the sheet with tab label "PlotData."

B20.3 Nomenclature for Annex B20 and RESULTS7-2.XLS

ABS	Absolute value
Apr	April
Aug	August
BESTEST	Building Energy Simulation Test and Diagnostic Method
BLAST 3.0	U.S. Army Building Loads Analysis and System Thermodynamics system, version 3.0, level 215

BLAST 3.0, max	BLAST 3.0 maximum of slab or basement test cases results
BLAST 3.0, min	BLAST 3.0 minimum of slab or basement test cases results
Btu	British thermal unit
Clg	Cooling
CO	Colorado
Coeff	Coefficient
DaysInMo	Days in month
Dec	December
Delta	Results difference
DOE-2.1E	DOE-2.1E version W54
DOE-2.1E, max	DOE-2.1E maximum of slab or basement test cases results
DOE-2.1E, min	DOE-2.1E minimum of slab or basement test cases results
Dif	Difference
Feb	February
HERS	Home Energy Rating System
Htg	Heating
Jan	January
Jul	July
Jun	June
Mar	March
Max	Maximum of example results
MBtu	Million British thermal units
Mean	Mean of example results
Min	Minimum of example results
MoEndJD	Month end julian date
Nov	November
NV	Nevada
Oct	October
Sep	September
SRES/SUN 5.7	SERIRES/SUNCODE 5.7
SRES/SUN, max	SERIRES/SUNCODE 5.7 maximum of slab or basement test cases results
SRES/SUN, min	SERIRES/SUNCODE 5.7 minimum of slab or basement test cases results
T1	Tier 1
T2	Tier 2
TMY	Typical Meteorological Year
Tot	Total
y	Year

B20.4 Tier 1 and Tier 2 Example Results. The following Tier 1 and Tier 2 example results tables and figures are included in RESULTS7-2.XLS.

Annual Results Tables:

Table	Title	Cell Range (within sheet "Tables_B20")
B20-1	HERS BESTEST Tier-1 Example Results – Annual or Seasonal Heating Loads (10 ⁶ Btu/y) for Colorado Springs, CO	B2 – I28
B20-2	HERS BESTEST Tier-1 Example Results – Delta Annual or Seasonal Heating Loads (10 ⁶ Btu/y) for Colorado Springs, CO	B30 – I55
B20-3	HERS BESTEST Tier-1 Example Results – Annual or Seasonal Sensible Cooling Loads (10 ⁶ Btu/y) for Las Vegas, NV	B57 – I71
B20-4	HERS BESTEST Tier-1 Example Results – Delta Annual or Seasonal Sensible Cooling Loads (10 ⁶ Btu/y) for Las Vegas, NV	B73 – I86
B20-5	HERS BESTEST Tier-2 Example Results – Annual or Seasonal Heating Loads (10 ⁶ Btu/y) for Colorado Springs, CO	B88 – I97
B20-6	HERS BESTEST Tier-2 Example Results – Delta Annual or Seasonal Heating Loads (10 ⁶ Btu/y) for Colorado Springs, CO	B99 – I07
B20-7	HERS BESTEST Tier-2 Example Results – Annual or Seasonal Sensible Cooling Loads (10 ⁶ Btu/y) for Las Vegas, NV ("AL") and Colorado Springs, CO ("AC")	B109 – I118
B20-8	HERS BESTEST Tier-2 Example Results – Delta Annual or Seasonal Sensible Cooling Loads (10 ⁶ Btu/y) for Las Vegas, NV ("AL") and Colorado Springs, CO ("AC")	B120 – I128

Monthly Results Tables:

Table	Title	"Sheet", Cell Range
B20-9	BLAST 3.0 Tier 1 Monthly and Total Heating Loads (million Btu)	"BLAST-HtgRes", B1 – Y15
B20-10	BLAST 3.0 Tier 2 Monthly and Total Heating Loads (million Btu)	"BLAST-HtgRes", AA1 – AG15
B20-11	BLAST 3.0 Tier 1 Monthly and Total Cooling Sensible Loads (million Btu)	"BLAST-ClgRes", B1 – M15
B20-12	BLAST 3.0 Tier 2 Monthly and Total Cooling Sensible Loads (million Btu)	"BLAST-ClgRes", O1 – U15
B20-13	DOE-2.1E Tier 1 Monthly and Total Heating Loads (million Btu)	"DOE-HtgRes", B1 – Y15
B20-14	DOE-2.1E Tier 2 Monthly and Total Heating Loads (million Btu)	"DOE-HtgRes", AA1 – AG15
B20-15	DOE-2.1E Tier 1 Monthly and Total Sensible Cooling Loads (million Btu)	"DOE-ClgRes", B1 – M15
B20-16	DOE-2.1E Tier 2 Monthly and Total Sensible Cooling Loads (million Btu)	"DOE-ClgRes", O1 – U15
B20-17	SERIRES/SUNCODE 5.7 Tier 1 Monthly and Total Heating Loads (million Btu)	"SRES-HtgRes", B1 – Y15
B20-18	SERIRES/SUNCODE 5.7 Tier 2 Monthly and Total Heating Loads (million Btu)	"SRES-HtgRes", AA1 – AG15
B20-19	SERIRES/SUNCODE 5.7 Tier 1 Monthly and Total Sensible Cooling Loads (million Btu)	"SRES-ClgRes", B1 – M15
B20-20	SERIRES/SUNCODE 5.7 Tier 2 Monthly and Total Sensible Cooling Loads (million Btu)	"SRES-ClgRes", O1 – U15

Figures

Figure	Title	Sheet Tab
B20-1	HERS BESTEST Tier-1 Example Results – Annual or Seasonal Heating Load (L100AC – L202AC), Colorado Springs, CO	Fig-B20-1_T1_Htg1
B20-2	HERS BESTEST Tier-1 Example Results – Annual or Seasonal Heating Load (L302AB – L324AB), Colorado Springs, CO	Fig-B20-2_T1_Htg2
B20-3	HERS BESTEST Tier-1 Example Results – Delta Annual or Seasonal Heating Load (L110AC – L202AC), Colorado Springs, CO	Fig-B20-3_T1_dHtg1
B20-4	HERS BESTEST Tier-1 Example Results – Delta Annual or Seasonal Heating Load (L302AB – L324AB), Colorado Springs, CO	Fig-B20-4_T1_dHtg2
B20-5	HERS BESTEST Tier-1 Example Results – Annual or Seasonal Sensible Cooling Load (L100AL – L150AL), Las Vegas, NV	Fig-B20-5_T1_Clg1
B20-6	HERS BESTEST Tier-1 Example Results – Annual or Seasonal Sensible Cooling Load (L155AL – L202AL), Las Vegas, NV	Fig-B20-6_T1_Clg2
B20-7	HERS BESTEST Tier-1 Example Results – Delta Annual or Seasonal Sensible Cooling Load (L110AL – L150AL), Las Vegas, NV	Fig-B20-7_T1_dClg1
B20-8	HERS BESTEST Tier-1 Example Results – Delta Annual or Seasonal Sensible Cooling Load (L155AL – L202AL), Las Vegas, NV	Fig-B20-8_T1_dClg2
B20-9	HERS BESTEST Tier-2 Example Results – Annual or Seasonal Heating Load (L165AC - P150AC), Colorado Springs, CO	Fig-B20-9_T2_Htg
B20-10	HERS BESTEST Tier-2 Example Results – Delta Annual or Seasonal Heating Load (L165AC - P150AC), Colorado Springs, CO	Fig-B20-10_T2_dHtg
B20-11	HERS BESTEST Tier-2 Example Results – Annual or Seasonal Sensible Cooling Load (L165AL – P150AC)	Fig-B20-11_T2_Clg
B20-12	HERS BESTEST Tier-2 Example Results – Delta Annual or Seasonal Sensible Cooling Load (L165AC – P150AC)	Fig-B20-12_T2_dClg

(This annex is not part of the standard. It is merely informative and does not contain requirements necessary for conformance to the standard. It has not been processed according to the ANSI requirements for a standard and may contain material that has not been subject to public review or a consensus process. Unresolved objectors on informative material are not offered the right to appeal at ASHRAE or ANSI.)

[Informative note: Informative Annex B21 is all new material. Underlining is not used to show additions to the current standard in this annex.]

INFORMATIVE ANNEX B21 PRODUCTION OF EXAMPLE RESULTS FOR SECTION 7 TEST PROCEDURES

The Section 7 example results were produced during 1994-1995. The following programs were used to generate the example results:

- BLAST 3.0 Level 215
- DOE2.1E - W54
- SUNCODE 5.7.

The following discussion relates to program status in 1995. BLAST was the program the U.S. Department of Defense used for energy efficiency improvements to its buildings.^{B-4} DOE2.1E was considered to be the most advanced of the programs sponsored by the U.S. Department of Energy and was the technical basis for setting national building energy codes and standards in the United States.^{B-12, B-13} SUNCODE is based on the public domain program SERIRES-1.0 developed by the National Renewable Energy Laboratory.^{B-14} The results for all three programs were developed by National Renewable Energy Laboratory and J. Neymark & Associates. For generating these results, along with using consistent modeling methods, the simulations were conducted using the most detailed modeling methods allowed by the software, within the constraints of the test specification.

B21.1 Discussion of Selected Results

B21.1.1 Detailed Ground Coupling Analysis Results for Cases L302B, L304B, L322B and L324B. The results for two types of ground coupling models included in Annex B20 effectively widen the range of example results outputs for cases that include ground-coupling analysis. This was done in case a residential modeling program is using a more sophisticated algorithm than the application of ASHRAE steady-state heat transfer coefficients. Case descriptions for the more detailed simulations of ground coupling in Cases L302B, L304B, L322B and L324B are provided in informative Annex B18. Some issues regarding simulation of detailed ground coupling with the software used for generating example results are noted below.

In BLAST and DOE2.1E, the mathematical algorithms limit the amount of mass that these programs can effectively model. Where soil thickness (conduction path length) was greater than what a program could handle (generally 2–3 feet, depending on the case), an allowable soil amount was

provided and the remaining thickness modeled as steady-state resistance.

In running the example results simulations, which are restricted to one-dimensional heat-flow modeling, the following methods were applied to approximate solar incidence on soil adjacent to the house:

- In BLAST, DOE2.1E and SERIRES/SUNCODE, slab floors were associated with a skyward-facing, horizontal solar-receiving surface, and exterior solar absorptance was reduced from 0.6 to 0.375 to account for shading half of direct beam radiation at any given time. Because BLAST automatically accounts for shading by the building, the horizontal receiving surface was located on the south side of the building to avoid double-counting the shading effect.
- In DOE2.1E and SERIRES/SUNCODE, below-grade walls were associated with a skyward-facing, horizontal solar-receiving surface, and exterior solar absorptance was reduced from 0.6 to 0.375 to account for shading half of direct beam radiation at any given time.
- In BLAST, below-grade walls were associated with skyward-facing, horizontal solar-receiving surfaces, exterior solar absorptance was kept at 0.6, and the horizontal receiving surfaces were positioned to be automatically shaded by the building.

B21.1.2 Exterior Surface Coefficient Effects. Part of the spread among the example results can be explained by different assumptions regarding treatment of heat transfer between external surfaces and the surrounding environment. This is especially evident in the Case L200A heating load output. A sensitivity test with SERIRES/SUNCODE, when comparing results using the combined exterior surface coefficients specified in Section 7 versus those calculated by DOE2.1E (DOE2.1E's annualized average was input to SERIRES/SUNCODE), indicates the following annual heating loads for Case L200A:

- SERIRES/SUNCODE with Section 7 exterior surface coefficient: 168 MBtu/y heating
- SERIRES/SUNCODE with DOE2.1E calculated exterior surface coefficient: 151 MBtu/y heating.

The roughly 10% effect of this parameter represents a legitimate algorithmic difference between the example results. Future research examining the preferred use of one algorithm over the other is justified by the magnitude of this effect.

(This annex is not part of the standard. It is merely informative and does not contain requirements necessary for conformance to the standard. It has not been processed according to the ANSI requirements for a standard and may contain material that has not been subject to public review or a consensus process. Unresolved objectors on informative material are not offered the right to appeal at ASHRAE or ANSI.)

[Informative note: Informative Annex B22 is all new material. Underlining is not used to show additions to the current standard in this annex.]

ANNEX B22 EXAMPLE PROCEDURES FOR DEVELOPING ACCEPTANCE-RANGE CRITERIA FOR SECTION 7 TEST CASES

This section is an informative annex that provides an example procedure for establishing acceptance range criteria to assess annual or seasonal heating and cooling load results from software undergoing tests contained in Section 7 of Standard 140. Users are reminded that inclusion of this example is intended to be illustrative only and that it does not imply in any way that results from software tests are required by Standard 140 to be within any specific limits. However, certifying or accrediting agencies using Section 7 of Standard 140 may wish to adopt procedures for developing acceptance-range criteria for tested software. This section presents an example range setting methodology that may be used for these purposes. This method was first proposed and described in *HERS BESTEST Volume 1*, pp. 138-141.^{B-1} Note also that the example ranges presented in this section are developed using fictitious reference results.

B22.1 Establishing Acceptance Ranges. A certifying or accrediting agency may develop acceptance-range setting criteria to suit particular needs. In choosing algorithms for determining acceptance ranges, it is important to consider the following:

1. Establishing a buffer range around reference results is desirable for the following reasons:
 - The reference results do not represent truth, but rather the state of the art in the simulation and analysis of buildings, therefore a result just outside the range of reference results should be acceptable
 - Where confidence interval ranges are very narrow, it is advisable to have additional buffer zone range expansion criteria so that software is not eliminated because of differences that are relatively insignificant in terms of energy consumption or energy cost quantities
2. The use of statistical confidence intervals^{B-15} provides some theoretical basis for developing acceptance ranges. The 93% confidence level was chosen for the example presented here because a 95% confidence interval would widen the acceptance range to a point where the test cases

lack meaning (are too easy to pass). Similarly, the acceptance range for an 80% confidence interval would be too narrow. We determined empirically that for most cases, confidence coefficients corresponding to confidence intervals in the range of 80% to 95% yield reasonable acceptance ranges.

3. Where reference results are very close together, such that the confidence interval maximum or minimum values could fall very close to the reference results maximum or minimum values, a value of $\pm 5\%$ of the base case (L100A) mean heating load is applied to the range. For the cases reported here, that value is ± 4 million Btu. This value is taken as a reasonable threshold of economic uncertainty. That is, any software disagreements within ± 4 million Btu of the reference results extremes for a given case, including difference (or "delta") cases, would result in relatively insignificant utility cost disagreements and therefore should not be cause for eliminating a given software tool, even if it falls outside of confidence limits based on the chosen confidence interval. Depending on fuel prices, climate, mortgage lending policy, and other circumstances in specific regions, it may make sense to adjust this criterion.
4. Some cases may deserve to have more strict acceptance criteria than would be generated using the range setting procedure described above. A possible example would be cases with higher absolute loads or higher load differences. In these cases, where the percentage variance between reference results can be roughly consistent with those for lower load cases, the higher values may produce an unreasonably large extension of the acceptance range in terms of estimated fuel cost. Acceptance ranges may be narrowed by altering the confidence interval, or the 4 million Btu buffer. However, the acceptance range must always include the maximum and minimum values of the reference results.

B22.2 Example of Procedure for Developing Acceptance Ranges. Table B22-1 presents example fictitious results and acceptance range limits that result from the example procedure described here. A step-by-step description of the procedures used to arrive at each element follows the table. Values indicated by bold font in Table B22-1 are the resulting acceptance range limit values for the fictitious results set, as determined using the example range setting criteria described below.

TABLE B22-1 Example Range Criteria Using Fictitious Reference Results

Description	Case #1 (10 ⁶ Btu)	Case #2 (10 ⁶ Btu)	Delta Case #1 - Case #2 (10 ⁶ Btu)
Reference Result #1	73.00	46.00	27.00
Reference Result #2	70.00	45.00	25.00
Reference Result #3	82.00	50.00	32.00
Ref Max	82.00	50.00	32.00
Ref Min	70.00	45.00	25.00
Ref Mean	75.00	47.00	28.00
Ref StDv	6.24	2.65	3.61
Ref 93% Conf Max	87.89	52.46	35.44
Ref 93% Conf Min	62.11	41.54	20.56
Ref Max + 4 million Btu (4.220 GJ)*	86.00	54.00	36.00
Ref Min - 4 million Btu (4.220 GJ)	66.00	41.00	21.00
Example Range Max	87.89	54.00	36.00
Example Range Min	62.11	41.00	20.56

* Note 4 million Btu = 4.220 GJ = 1.172 MWh.

- Using Reference Results #1, #2 and #3 from Table B22-1, determine the maximum reference result, the minimum reference result, the sample mean (average) of the reference results, and the sample standard deviation (using n-1 method) of the reference results. These quantities are shown in Table B22-1 as "Ref Max," "Ref Min," "Ref Mean" and "Ref StDv," respectively.
- Calculate the 93% confidence interval for the population sample mean assuming a Student's t distribution based on the reference results.^{B-15} The extremes (confidence limits) of the 93% confidence interval for the population mean are determined from:

$$L_a = X + (t_c)(s)/(N)^{1/2} \quad (\text{B22-1})$$

$$L_b = X - (t_c)(s)/(N)^{1/2} \quad (\text{B22-2})$$

where:

- L_a = maximum confidence limit for the confidence interval
- L_b = minimum confidence limit for the confidence interval
- X = sample mean
- t_c = confidence coefficient, see below
- s = sample standard deviation
- N = number of samples.

The confidence coefficient (t_c) is determined by the sample size and the desired confidence interval. For this example, with a sample size of three (N = 3), t_c is calculated from Equation B22-1 or B22-2 to match the original HERS BESTEST (Appendix H)^{B-1} confidence limits, resulting in:

$$t_c = 3.576255 \text{ [from } t_c = 2.92 \times (3)^{1/2} / (2)^{1/2}] \quad (\text{B22-3})$$

For t_c = 3.576255, 2 degrees of freedom (number of samples = 3), and 2 tails, Excel's TDIST() function (which applies a Student's t distribution) returns a probability of 0.07007, which corresponds to a 93% (92.993%) confidence interval. Equations B22-1 and B22-2 then become:

$$L_a = X + 3.576(s)/3^{1/2} \quad (\text{B22-4})$$

$$L_b = X - 3.576(s)/3^{1/2} \quad (\text{B22-5})$$

The resulting confidence limits are shown in Table B22-1 as "Ref 93% Conf Max" and "Ref 93% Conf Min." Table B22-2 provides a limited set of Student's t confidence coefficients that may be used for other sample sizes and confidence intervals. Additional tables for other confidence limits and sample sizes are available in many statistics text books.

TABLE B22-2 Sample Student's t Confidence Coefficients (t_c)

Sample Size (n)	Desired Confidence Interval		
	80%	90%	95%
2	3.078	6.314	12.706
3	1.886	2.920	4.303
4	1.638	2.353	3.182
5	1.533	2.132	2.776
6	1.476	2.015	2.571
7	1.440	1.943	2.447
8	1.415	1.895	2.363

3. Calculate:

$$(\text{Ref Max}) + 4 \text{ million Btu (4.220 GJ)}$$

and

$$(\text{Ref Min}) - 4 \text{ million Btu (4.220 GJ)}$$

The results of these calculations are shown in Table B22-1 as "Ref Max + 4 million Btu (4.220 GJ)" and "Ref Min - 4 million Btu (4.220 GJ)."

4. The example acceptance range ("Range Max," "Range Min") is then determined by taking the maximum of "Ref 93% Conf Max" and "Ref Max + 4 million Btu (4.220 GJ)" as "Range Max" and the minimum of "Ref 93% Conf Min" and "Ref Min - 4 million Btu (4.220 GJ)" as "Range Min". Using Table B22-1, a software tool passes a case if its test result falls within the "Range Max" and "Range Min" for that case. Note, in Table B22-1, that fictitious sets of results are used, such that the confidence interval range setting and the "Ref Max + 4 million Btu (4.220 GJ)" and "Ref Min - 4 million Btu (4.220 GJ)" ranges set the range extremes for Case #1 and Case #2, respectively. It is also possible to have results where one range setting method sets one extreme and the other range setting method sets the other extreme, as shown in the "Delta Case #1 - Case #2" result of Table B22-1.

For this example, a software tool would "pass" a particular test case if its result for that test case falls within the acceptance range represented by "Example Range Max" and "Example Range Min" in Table B22-1. Similarly, a software tool would pass a test suite if its results for *all* test cases in a given test suite fall within all acceptance ranges, including for both the absolute cases and the difference (or "delta") cases.

This type of example procedure for developing acceptance ranges was first developed for use with *HERS BESTEST* B-1. An example of applying this procedure to the *HERS BESTEST* reference results is included in *HERS BESTEST, Volume 2, Section 4*.^{B-10}

B22.3 Procedure for Developing Example Acceptance Ranges for HERS Programs that Designate Heating and Cooling Seasons. The same procedure described above may be applied to developing acceptance ranges for software programs that designate heating and cooling seasons. In this case, the annual reference results must be replaced by seasonal ref-

erence results developed from the monthly output corresponding to the designated heating and cooling seasons of the software tool undergoing the tests. For comparing modeling tools that designate heating or cooling seasons, or both, as beginning/ending during mid-month, linearly interpolate the monthly reference results for given months as appropriate. The remainder of the range development procedure is the same.

(This annex is not part of the standard. It is merely informative and does not contain requirements necessary for conformance to the standard. It has not been processed according to the ANSI requirements for a standard and may contain material that has not been subject to public review or a consensus process. Unresolved objectors on informative material are not offered the right to appeal at ASHRAE or ANSI.)

[Informative note: Only change to Annex B18 is to renumber as Annex B23 as shown below.]

**INFORMATIVE ANNEX-B18 B23
VALIDATION METHODOLOGIES AND OTHER
RESEARCH RELEVANT TO STANDARD 140**

(This annex is not part of the standard. It is merely informative and does not contain requirements necessary for conformance to the standard. It has not been processed according to the ANSI requirements for a standard and may contain material that has not been subject to public review or a consensus process. Unresolved objectors on informative material are not offered the right to appeal at ASHRAE or ANSI.)

**INFORMATIVE ANNEX B19-B24
INFORMATIVE REFERENCES**

[Informative Note: All references listed below are cited in new addendum language (some of these may be already cited in 140-2007).]

B-1 Judkoff, R., and J. Neymark. (1995). *Home Energy Rating System Building Energy Simulation Test (HERS BESTEST), Volume 1: Tier 1 and Tier 2 Tests User's Manual*.

- NREL/TP-472-7332a. Golden, CO: National Renewable Energy Laboratory.
<http://www.nrel.gov/docs/legosti/fy96/7332a.pdf>
- B-2 RESNET, *2006 Mortgage Industry National Home Energy Rating Systems Standards*. Residential Energy Services Network, Oceanside, CA, November 2007.
- B-3 McQuiston, F. and J. Spitler. (1992). *Cooling and Heating Load Calculation Manual*. Second Edition. Atlanta, GA: American Society of Heating, Refrigerating, and Air-Conditioning Engineers; p. 4.12.
- B-4 *BLAST User Reference, Volumes 1 and 2*. (1991). BLAST Support Office. Urbana, IL: University of Illinois.
- B-5 Kennedy, M.; L. Palmiter; and T. Wheeling. (1992). *SUN-CODE-PC Building Load Simulation Program*. Available from Ecotope, Inc., 2812 E. Madison, Seattle, WA, 98112, (206) 322-3753. This software is based on SERIRES-1.0 developed at NREL. See also Palmiter et al.^{B-14}
- B-6 *WINDOW 4.1*. (March 1994.) Lawrence Berkeley Laboratory, Berkeley, CA 94720, LBL-35298.
- B-7 *1993 ASHRAE Handbook—Fundamentals*. Atlanta, GA: American Society of Heating, Refrigerating, and Air-Conditioning Engineers; pp. 25.10-25.12 and elsewhere, as noted in the text.
- B-8 Wang, F.S. (1979.) "Mathematical Modeling and Computer Simulation of Insulation Systems in Below Grade Applications." Presented at ASHRAE/DOE Conference on Thermal Performance of the Exterior Envelopes of Buildings, Orlando, FL, December.
- B-9 Latta, J.K. and G.G. Boileau. (1969). *Heat Losses from House Basements*. Canadian Building 19(10):39.
- B-10 Judkoff, R., and J. Neymark. (1995). *Home Energy Rating System Building Energy Simulation Test (HERS BESTEST), Volume 2: Tier 1 and Tier 2 Tests Reference Results*. NREL/TP-472-7332b. Golden, CO: National Renewable Energy Laboratory. <http://www.nrel.gov/docs/legosti/fy96/7332b.pdf>.
- B-11 Judkoff, R., and J. Neymark. (1995). *International Energy Agency Building Energy Simulation Test (BESTEST) and Diagnostic Method*. NREL/TP-472-6231. Golden, CO: National Renewable Energy Laboratory. <http://www.nrel.gov/docs/legosti/old/6231.pdf>.
- B-12 *DOE-2 Reference Manual (Version 2.1A) Part 1*. (May 1981). D. York and C. Cappiello, eds. Berkeley, CA: Lawrence Berkeley Laboratory.
- B-13 *DOE-2 Supplement (Version 2.1E)*. (January 1994). Berkeley, CA: Lawrence Berkeley Laboratory.
- B-14 Palmiter, M.L., T. Wheeling, R. Judkoff, B. O'Doherty, D. Simms, and D. Wortman. (1983). *Solar Energy Research Institute Residential Energy Simulator (Version 1.0)*. Golden, CO: Solar Energy Research Institute (now NREL).
- B-15 Spiegel, M.R. (1961). *Schaum's Outline of Theory and Problems of Statistics*. New York, NY: McGraw-Hill.

**POLICY STATEMENT DEFINING ASHRAE'S CONCERN
FOR THE ENVIRONMENTAL IMPACT OF ITS ACTIVITIES**

ASHRAE is concerned with the impact of its members' activities on both the indoor and outdoor environment. ASHRAE's members will strive to minimize any possible deleterious effect on the indoor and outdoor environment of the systems and components in their responsibility while maximizing the beneficial effects these systems provide, consistent with accepted standards and the practical state of the art.

ASHRAE's short-range goal is to ensure that the systems and components within its scope do not impact the indoor and outdoor environment to a greater extent than specified by the standards and guidelines as established by itself and other responsible bodies.

As an ongoing goal, ASHRAE will, through its Standards Committee and extensive technical committee structure, continue to generate up-to-date standards and guidelines where appropriate and adopt, recommend, and promote those new and revised standards developed by other responsible organizations.

Through its *Handbook*, appropriate chapters will contain up-to-date standards and design considerations as the material is systematically revised.

ASHRAE will take the lead with respect to dissemination of environmental information of its primary interest and will seek out and disseminate information from other responsible organizations that is pertinent, as guides to updating standards and guidelines.

The effects of the design and selection of equipment and systems will be considered within the scope of the system's intended use and expected misuse. The disposal of hazardous materials, if any, will also be considered.

ASHRAE's primary concern for environmental impact will be at the site where equipment within ASHRAE's scope operates. However, energy source selection and the possible environmental impact due to the energy source and energy transportation will be considered where possible. Recommendations concerning energy source selection should be made by its members.